



Sliding door systems

SALICE

S20



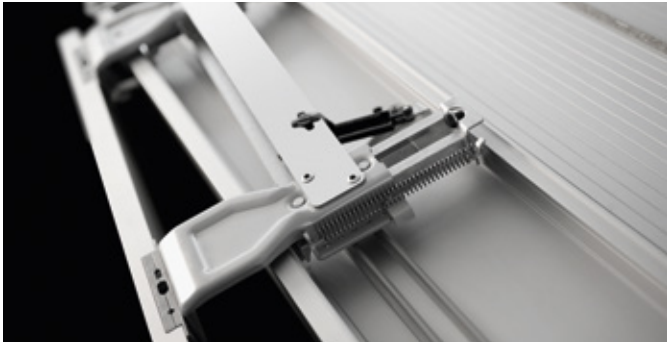





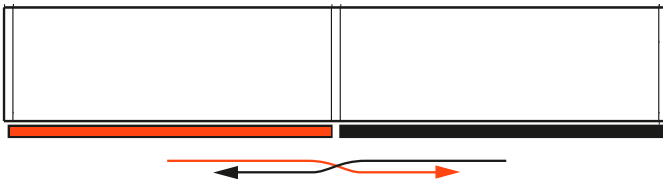

Coplanar sliding door system for double door wall cabinets with soft opening and soft closing feature.

Product overview

- For wood or glass with aluminum frame doors;
- Door dimensions:
 - Max. weight capacity per door: 20 kg (44 lbs);
 - Width of the door: min. 600 mm (23-5/8"), max. 1500 mm (59");
 - Max. height of the door: 1200 mm (47-7/32");
 - Thickness of the door: min. 19 mm (3/4"), max. 25 mm (1");
 - Max. thickness of the door with handle: 45 mm (1-3/4");
 - Min. distance of the handle from the edge of the door: 20 mm (13/16");
- Door height adjustment: $\pm 4.5\text{mm}$ ($\pm 3/16"$);
- Door side adjustment: $\pm 3\text{mm}$ ($\pm 1/8"$);
- Available also in motorized version only upon request as a custom order.



THE KIT ASSEMBLY CONSISTS OF:

A		1 upper sliding mechanism complete.
B		1 lower guide track;
C		2 connecting rods;
D	 <p>2 sets of upper and lower bracket arms for connecting rods</p> <p>1 hexagonal key of metric 2.5 mm ($3/32"$).</p>	 <p>For each door</p> <p>2 sets of door adjuster blocks;</p> <p>x 2</p>
E	 <p>For each mechanism</p> <p>4 adhesive buffers,</p> <p>1 wrench 3 mm</p>	

Upper slide mechanism fixed to the top of the cabinet.

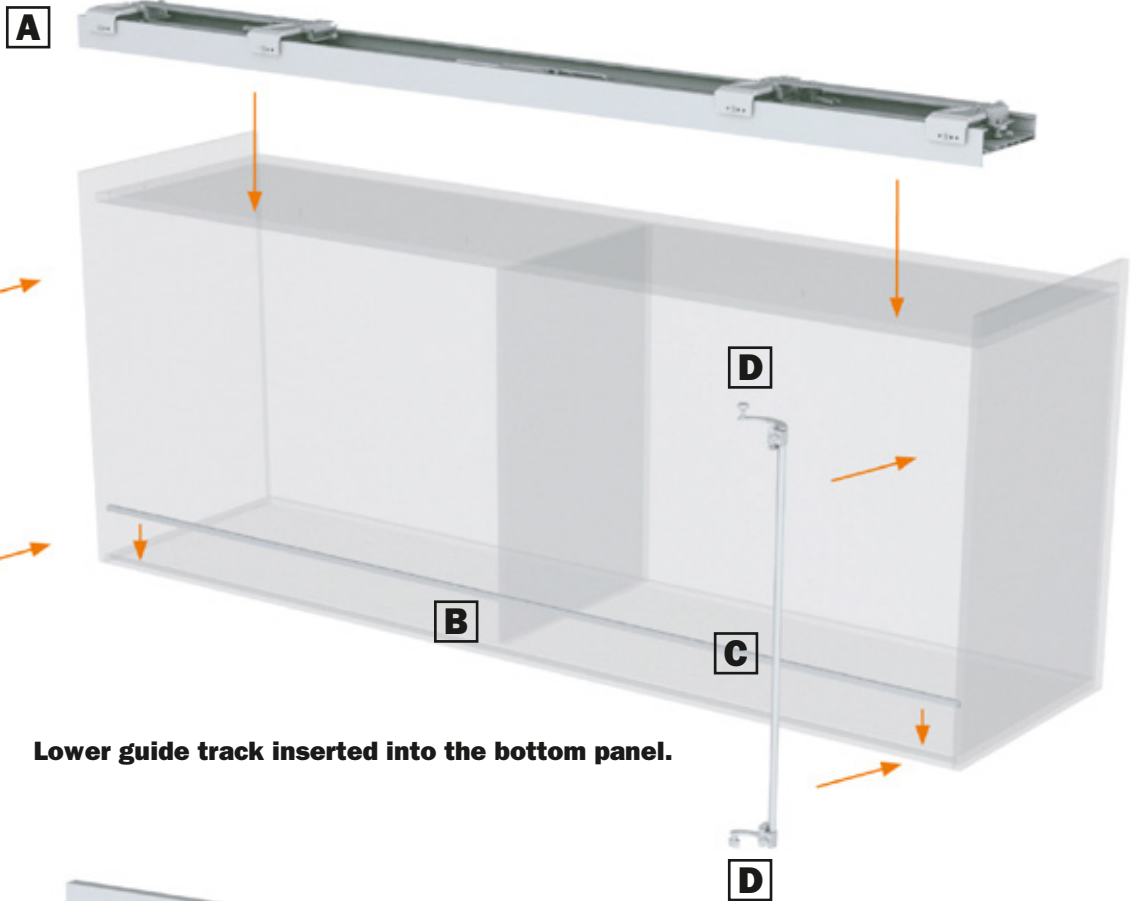

Lower guide track inserted into the bottom panel.



Position the adjuster blocks on the door.

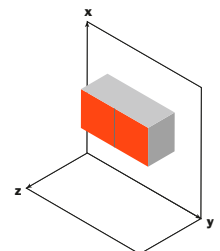

Slider S20 - Wall cabinet

CODE REFERENCES

- LI** Internal cabinet width (mm)
- LA** Door width (mm)
- HI** Internal cabinet height (mm)
- SPI** Center panel thickness (mm)
- SAB** Door overlay on bottom panel (mm)

- SAE** Door overlay on side panel (mm)
- SPC** Top panel thickness (mm)
- HA** Door height (mm)
- A/B** See chart

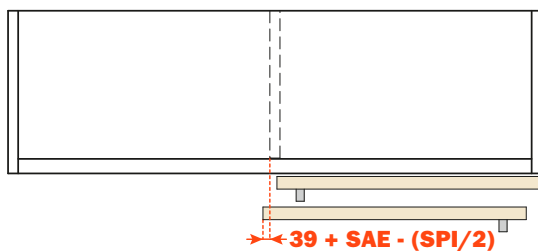
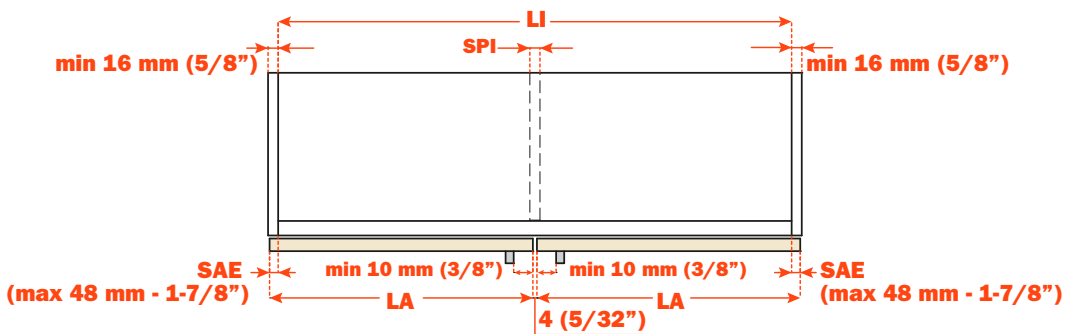
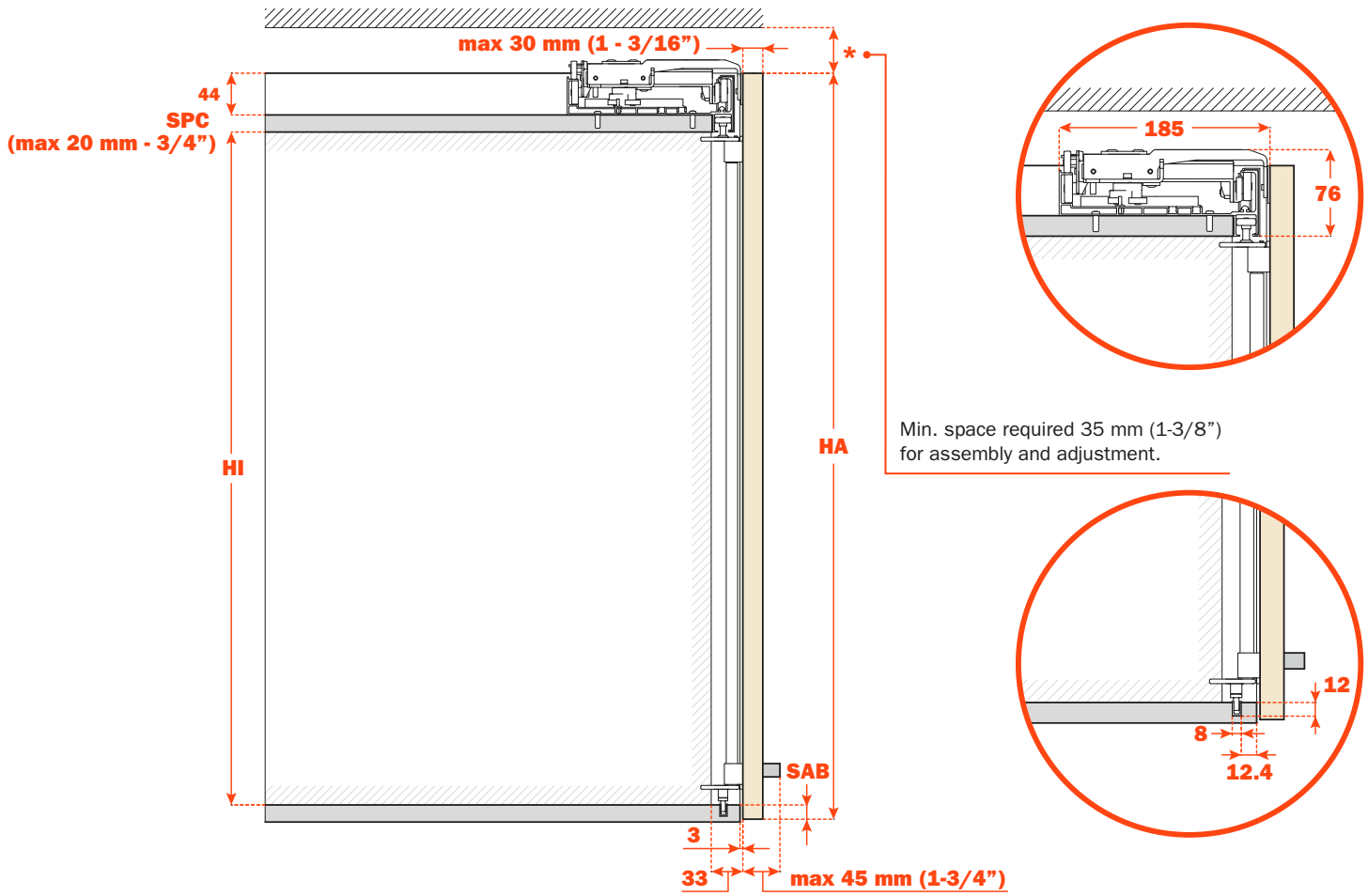

Product codes and assembly specifications

Item	Mechanism Length mm	LI	Overlay (SAE) mm	A	B	Packaging	
						Weight Kg	Dimensions cm
YE292AP1200SA	1161	1162	1 - 48	579	205.5	6.6	131x22x10
YE292AP1400SA	1361	1362	1 - 48	679	255.5	7.7	151x22x10
YE292AP1600SA	1561	1562	1 - 48	779	305.5	8.9	171x22x10
YE292AP1800SA	1761	1762	1 - 48	879	355.5	10	181x22x10
YE292AP2000SA	1961	1962	1 - 48	979	405.5	11	211x22x10
YE292AP2200SA	2161	2162	1 - 48	1079	455.5	11.9	231x22x10
YE292AP2400SA	2361	2362	1 - 48	1179	505.5	12.8	251x22x10
YE292AP2600SA	2561	2562	1 - 48	1279	555.5	14.3	271x22x10
YE292AP2800SA	2761	2762	1 - 48	1379	605.5	15.4	291x22x10
YE292AP3000SA	2961	2962	1 - 48	1479	655.5	16.4	311x22x10

For mechanisms greater of 3000 mm please contact our technical department.



As you are in the design phase it will be important to determine the weight of your doors and provide for it with adequate panels thickness.

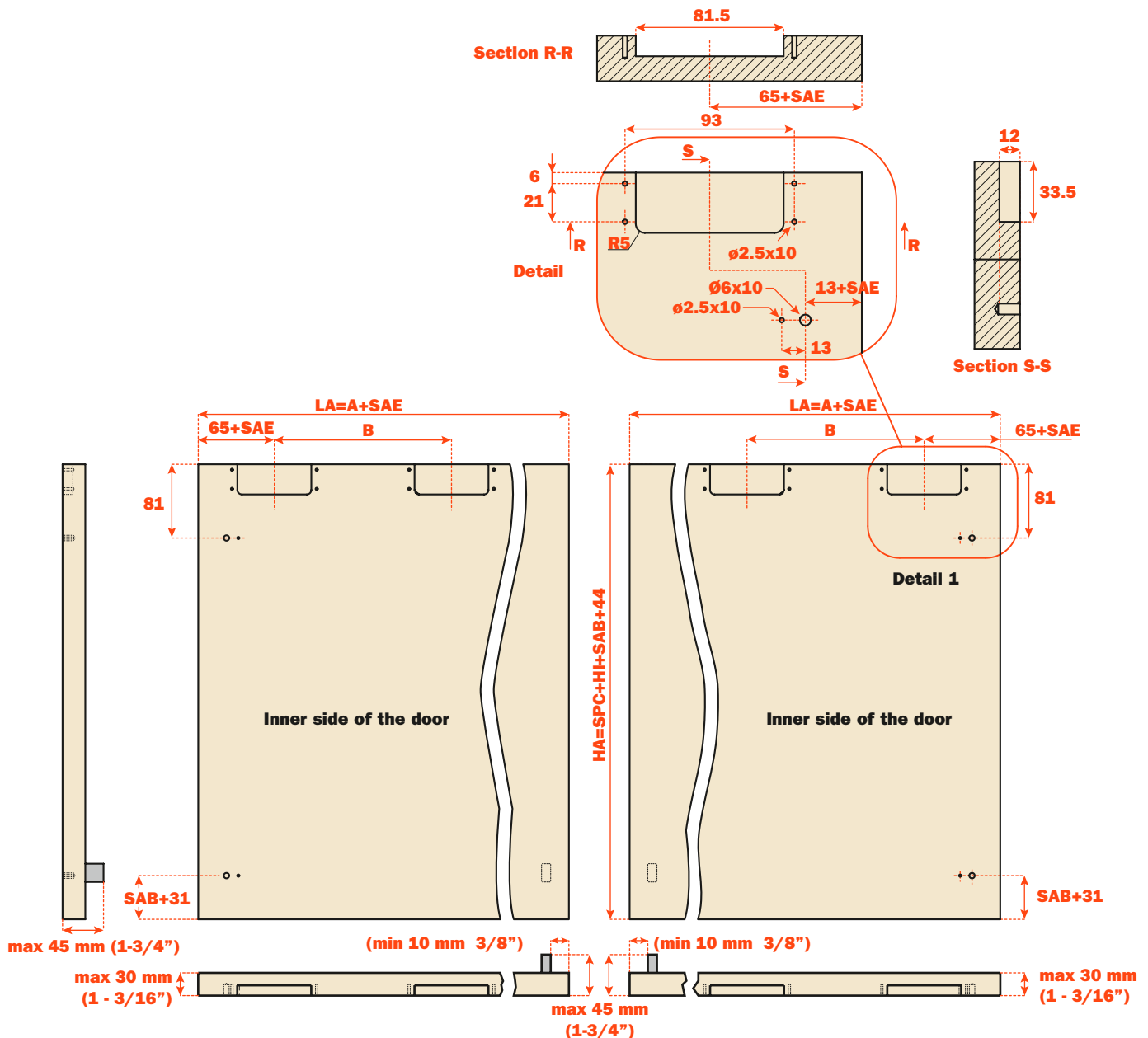









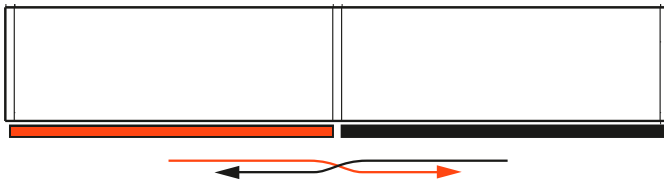

Coplanar sliding door system for double door base cabinets with soft opening and soft closing feature.

Product overview

- For wood or glass with aluminium frame doors;
- Door dimensions:
 - Max. weight capacity per door: 20 kg (44 lbs);
 - Width of the door: min. 600 mm (23-5/8"), max. 1500 mm (59");
 - Max. height of the door: 1200 mm (47-7/32");
 - Thickness of the door: min. 19 mm (3/4"), max. 25 mm (1");
 - Max. thickness of the door with handle: 45 mm (1-3/4");
 - Min. distance of the handle from the edge of the door: 20 mm (13/16");
- Door vertical adjustment: $\pm 4.5\text{mm}$ ($\pm 3/16"$);
- Door horizontal adjustment: $\pm 3\text{mm}$ ($\pm 1/8"$);
- Available also in motorized version only upon request as a custom order.



THE KIT ASSEMBLY CONSISTS OF:

A		1 lower sliding mechanism
B		1 upper guide track
C	 x 4 / 6 / 8	For each mechanism 4 / 6 / 8 fixing clips for upper guide runner
D	 x 1	For each door 2 guides for upper runner
E	 x 2	For each mechanism 2 couples of door adjuster blocks
F		For each mechanism 2 upper brackets
G		For each mechanism 2 cover plates for upper brackets
		 4 adhesive buffers 1 wrench 3 mm

Upper guide track fixed under the top panel

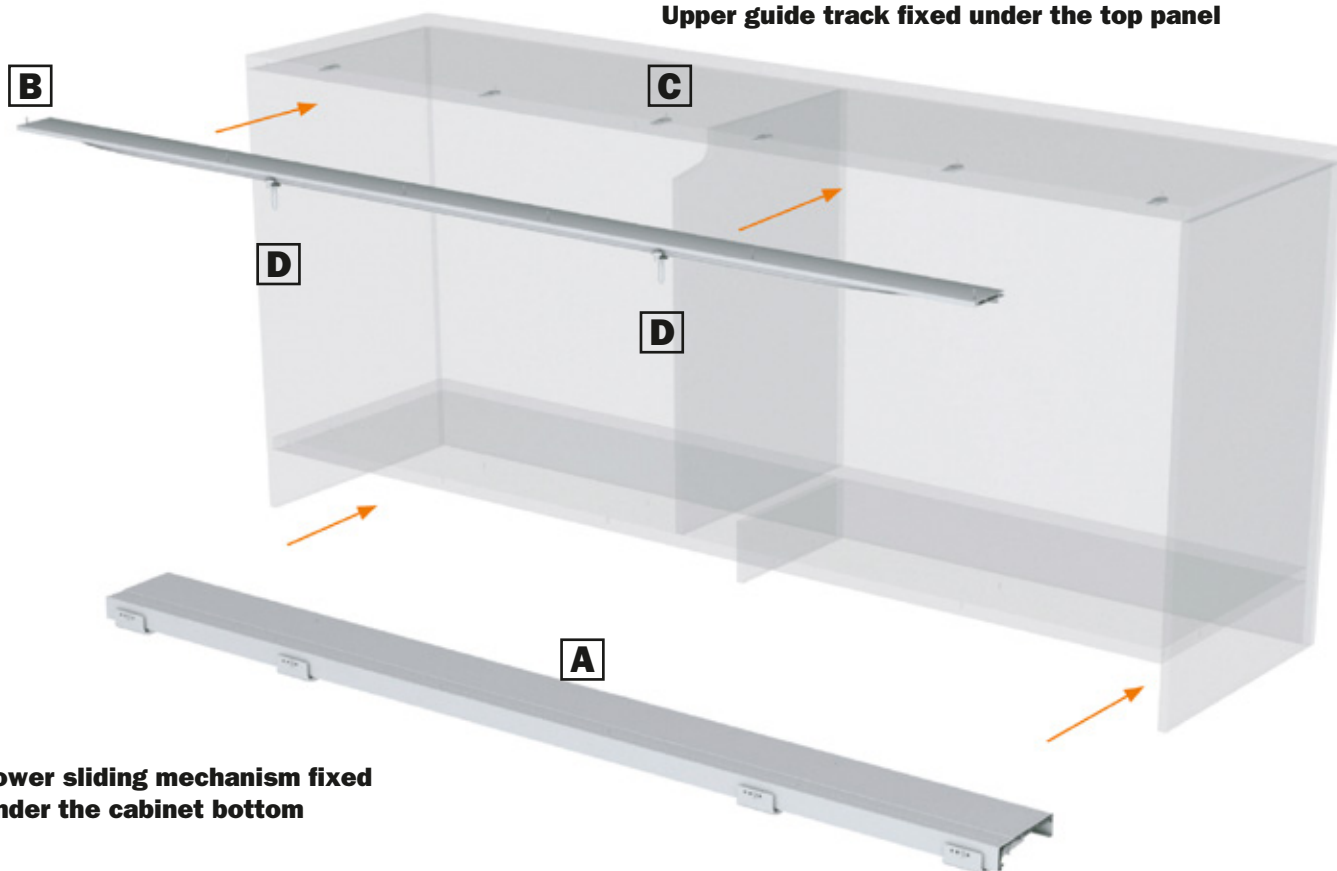

Lower sliding mechanism fixed under the cabinet bottom

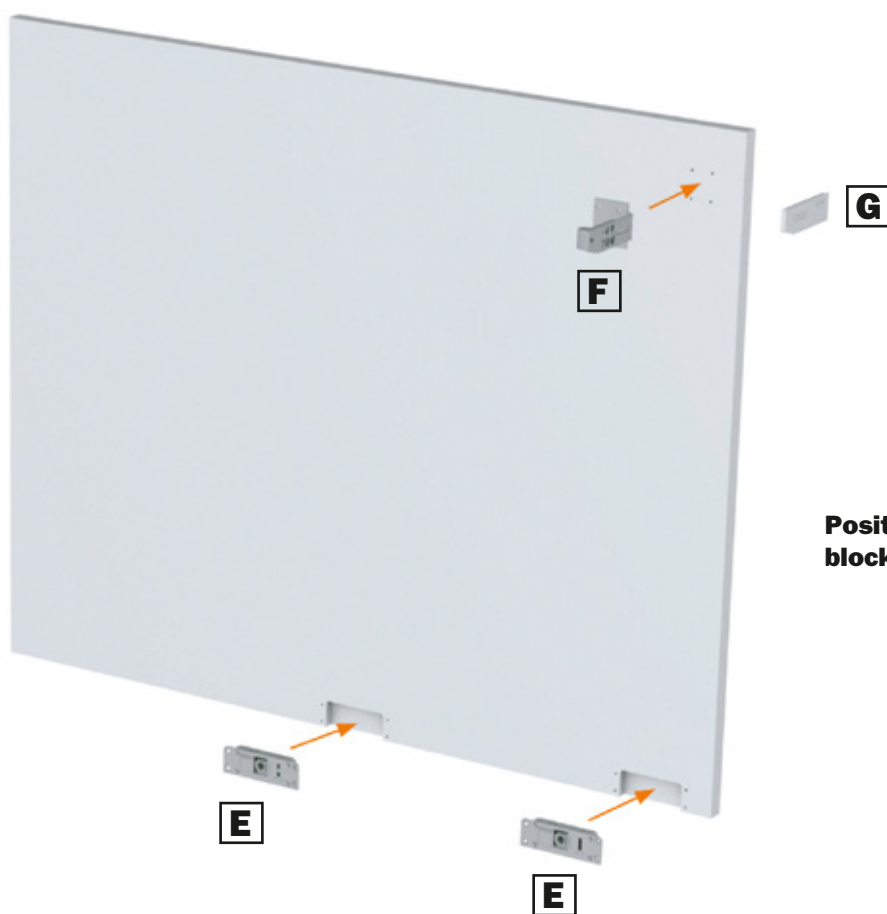

Position the adjuster blocks on the doors

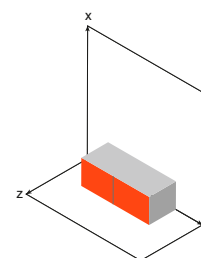

Slider S20 - Base cabinet

CODE REFERENCES

- LI** Internal cabinet width (mm)
- LA** Door width (mm)
- HI** Internal cabinet height (mm)
- SPI** Central panel thickness (mm)

- SAE** Door overlay on side panel (mm)
- SAC** Door overlay on top panel (mm)
- SPB** Bottom panel thickness (mm)
- HA** Door height (mm)
- A/B** See chart

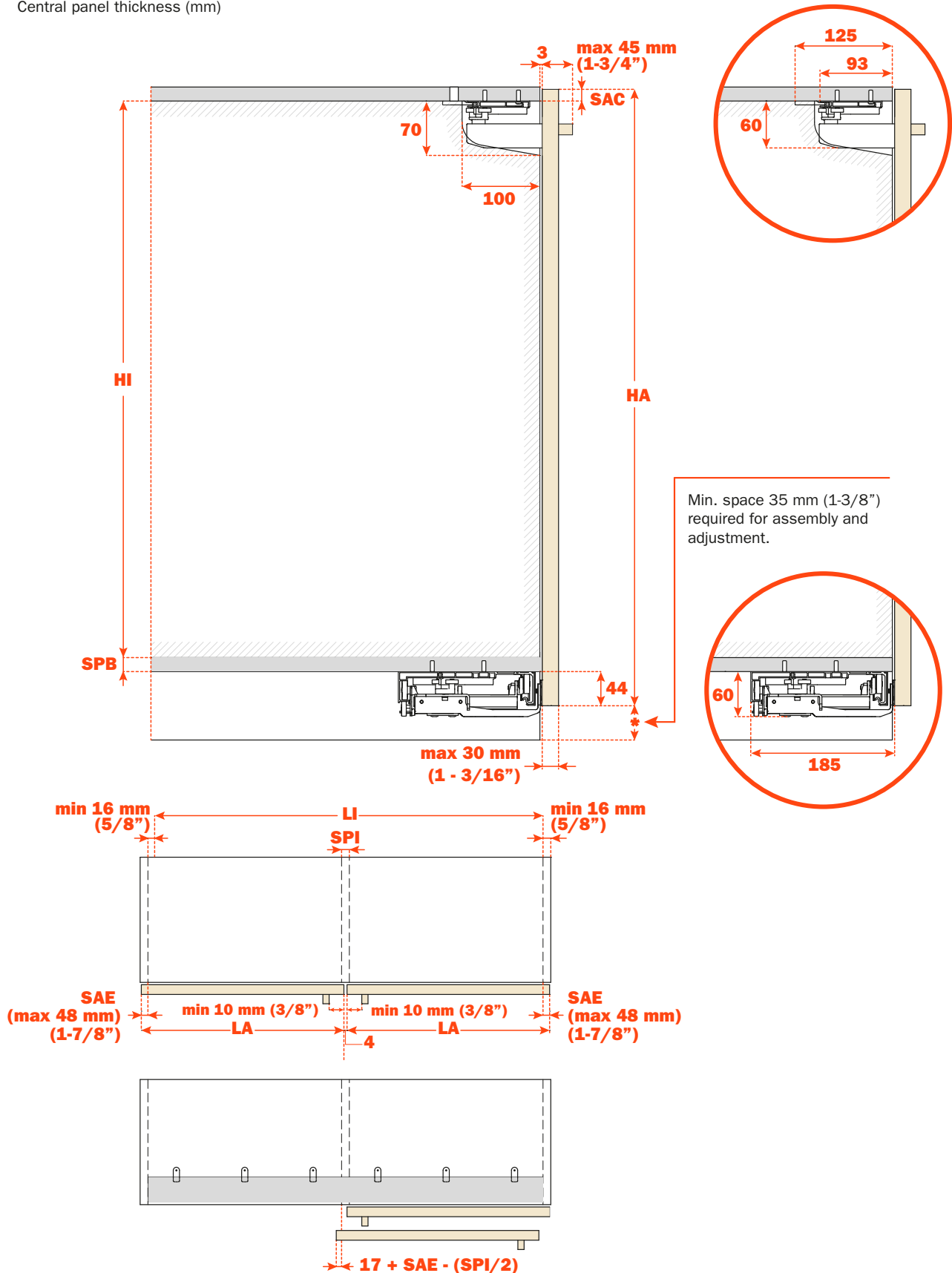

Item	Mechanism Length mm	LI	Overlay (SAE) mm	A	B	Packaging	
						Weight kg	Dimensions cm
YE292AM1200SA	1161	1162	1 - 48	579	194.5	6.6	131x22x10
YE292AM1400SA	1361	1362	1 - 48	679	244.5	7.7	151x22x10
YE292AM1600SA	1561	1562	1 - 48	779	294.5	8.9	171x22x10
YE292AM1800SA	1761	1762	1 - 48	879	344.5	10	181x22x10
YE292AM2000SA	1961	1962	1 - 48	979	394.5	11	211x22x10
YE292AM2200SA	2161	2162	1 - 48	1079	444.5	11.9	231x22x10
YE292AM2400SA	2361	2362	1 - 48	1179	494.5	12.8	251x22x10
YE292AM2600SA	2561	2562	1 - 48	1279	544.5	13.8	271x22x10
YE292AM2800SA	2761	2762	1 - 48	1379	594.5	14.9	291x22x10
YE292AM3000SA	2961	2962	1 - 48	1479	644.5	15.9	311x22x10

For mechanisms greater of 3000 mm please contact our technical department.



As you are in the design phase it will be important to determine the weight of your doors and provide for it with adequate panels thickness.

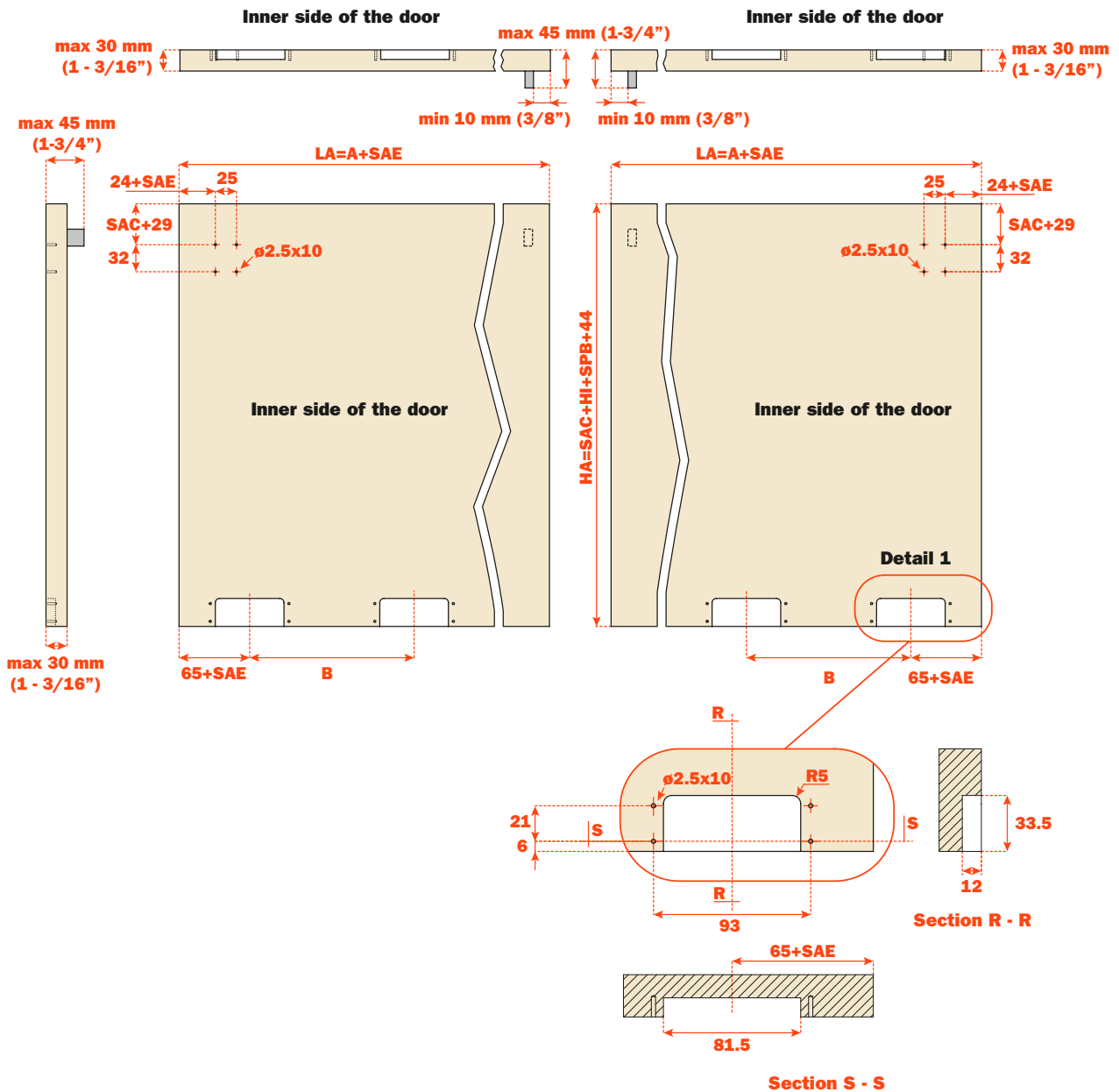

M50 +





Specifications for mechanisms with overall lengths between 2000 mm (78-3/4") - 2799 mm (110-3/16")

- Max. door height: 3000 mm (118-1/8");
- Adaptability to carcasses up to 200 mm (7-7/8") wider than the track;

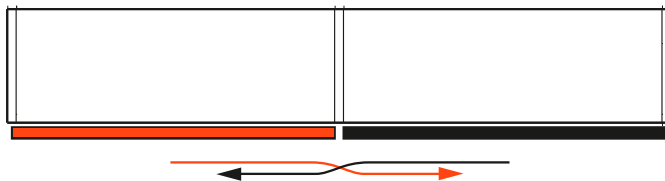

Product overview

Coplanar sliding door system for tall double door cabinets with soft opening and closing feature.

- For wood or glass with aluminum frame doors;
- Maximum weight capacity per door: 50 Kg (110 lbs);

Door dimensions:

- Soft opening and closing of the doors;
- Width of the door: min 600 mm (23-5/8"), max 2000 mm (78-3/4");
- Height of the door from floor level: 17 mm (11/16");
- Door height adjustment: ± 5 mm (3/16");
- Door side adjustment: ±3.5 mm (1/8");
- Compatible with our Clipper-aluminum door system.

Available also in motorized version with max. weight door of 35 Kg (77 Lbs) only upon request as a custom order;

Specifications for mechanisms with overall lengths between 1199 mm (47-7/32") and 1599 mm (63")

- Max. door height: 2200 mm (86-5/8");
- Adaptability to cabinets up to 100 mm (4") wider than the track.

Specifications for mechanisms with overall lengths between 1600 mm (63") and 1999 mm (78-3/4")

- Max. door height: 2400 mm (95-1/2");
- Adaptability to cabinets up to 200 mm (7-7/8") wider than the track.

THE KIT ASSEMBLY CONSISTS OF

A		Upper sliding mechanism.
B		Lower sliding mechanism.
		Front covers.
C	<p>For each sliding mechanism</p> <p>Note: The quantity of clips will vary according to the track sizes.</p> <ul style="list-style-type: none"> - Upper track fixing clip; - Lower track fixing clip. 	D <p>For each door</p> <ul style="list-style-type: none"> 1 horizontal and vertical adjuster; 1 vertical adjuster; 4 die-cast bushings M6x23; 4 special screws TE M6x22.
E	<p>For each door</p> <p>2 spacers for surface mounted adjusters.</p>	F <p>For each sliding mechanism</p> <p>2 bushings M6x13.</p>
<p>For each sliding mechanism</p> <ul style="list-style-type: none"> 1 hex wrench 4 mm; 1 wrench metric 10 mm; 4 black bumpers; 4 screws TCEI M5x16. 		

Upper sliding mechanism fixed to the top of the cabinet

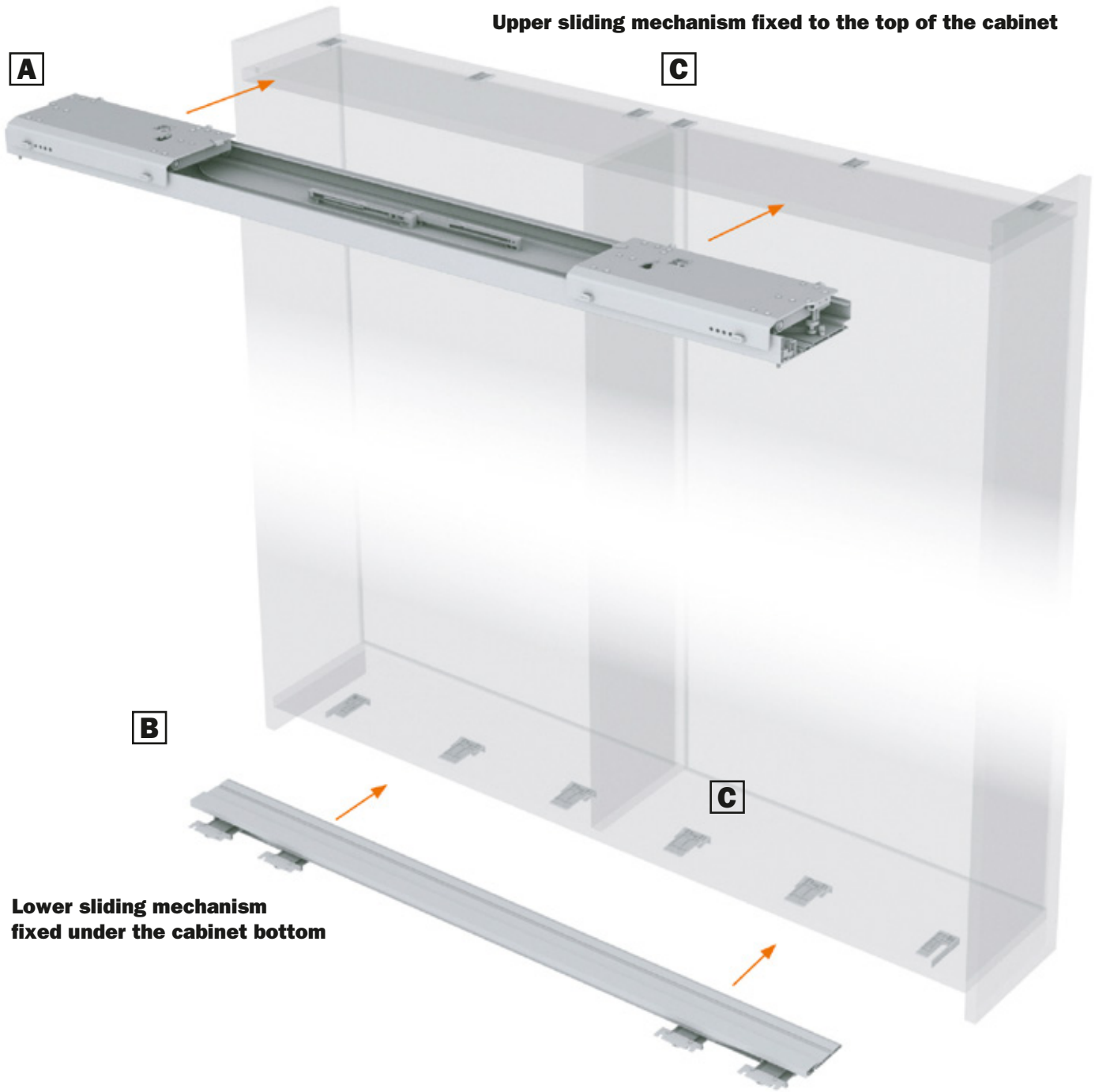

Lower sliding mechanism fixed under the cabinet bottom

Recessed-mounted adjusters

Door thickness: min 19 mm (3/4"), max. 45 mm (1-3/4") (including handle protrusion)



Surface mount adjusters

Door thickness: min 19 mm (3/4"), max. 40 mm (1-9/16") (including handle protrusion)

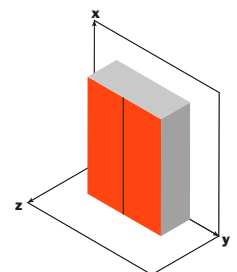

* With Clipper frame + 6 mm (1/4")

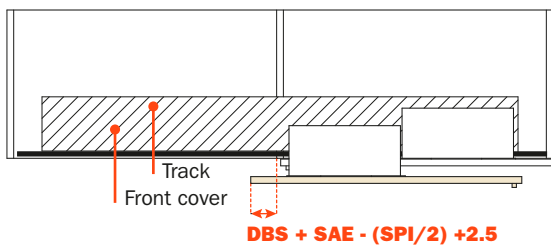
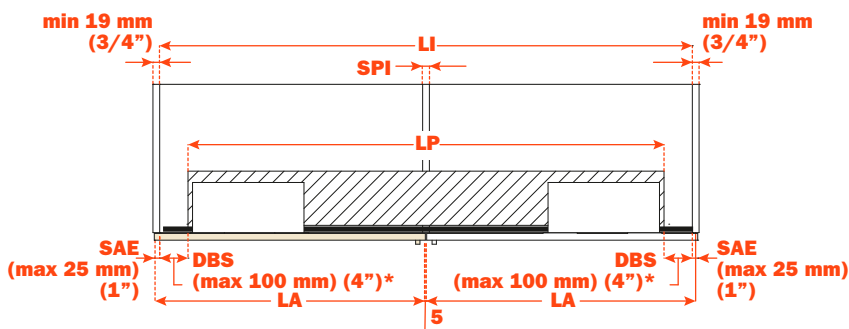
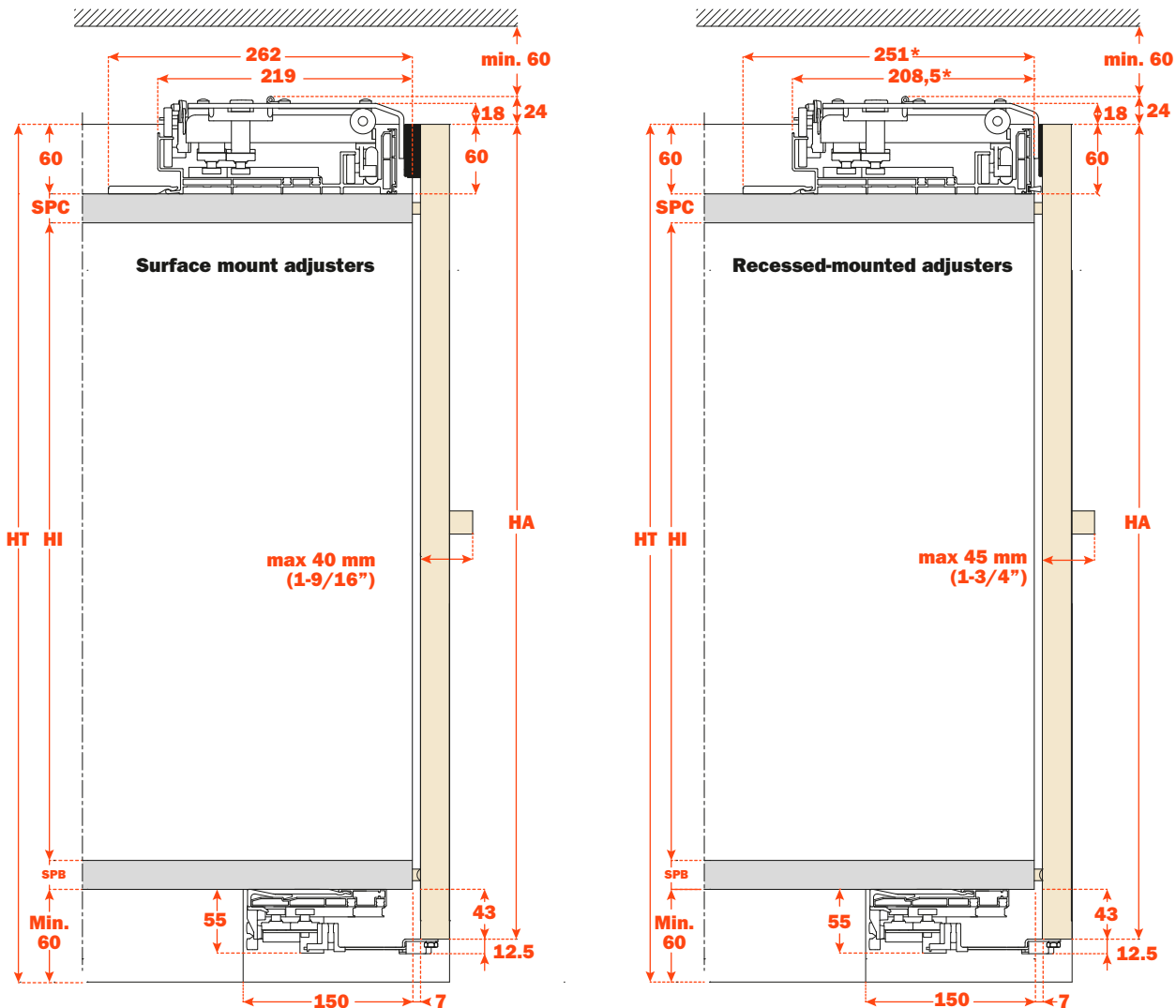

The M50 + Stock size slider mechanisms can be installed on a carcass which may exceed the dimensions of the track itself by 100/200 mm (4" to 7-7/8"). The protrusion of the door in a open position is describe with the formula:
 $DBS + SAE - (SPI/2) + 2.5$

CODE REFERENCES

- LI** Internal cabinet width (ID) (mm)
- LA** Door width (mm)
- HI** Internal cabinet height (mm)
- SPI** Support panel thickness (mm)
- SAE** Door overlay on side panel (mm)
- SPC** Top panel thickness
- SPB** Bottom panel thickness
- HA** Door height (mm)
- HT** Total cabinet height (mm)
- DBS** Space between track and side panel (mm)
- LP** Track length

* **DBS** max 50 mm (2") for mechanisms between 1199 mm (47-7/32") and 1499 mm (59")

Product codes and assembly specifications
Recessed-mounted adjusters

Item #	Track length (Lp) mm	Li	Overlay (SAE) mm	A	B	C	D	Packaging		Clipper frame	Max door Height mm
								Kg	cm		
YE512AM501200SU	1199	1200-1300	1 - 25	344	179	310.4	101.6	17.8	132x25x17	NO	2200
YE512AM501300SU	1299	1300-1400	1 - 25	369	204	335.4	126.6	18.7	142x25x17	NO	2200
YE512AM501400SU	1399	1400-1500	1 - 25	394	204	360.4	151.6	19.6	152x25x17	NO	2200
YE512AM501500SU	1499	1500-1600	1 - 25	419	254	385.4	176.6	20.7	162x25x17	NO	2200
YE512AM501600SU	1599	1600-1800	1 - 25	444	254	410.4	176.6	21.5	172x25x17	YES	2400
YE512AM501800SU	1799	1800-2000	1 - 25	494	304	460.4	226.6	23.3	192x25x17	YES	2400
YE512AM502000SU	1999	2000-2200	1 - 25	544	354	510.4	276.6	25	212x25x17	YES	3000
YE512AM502200SU	2199	2200-2400	1 - 25	594	404	560.4	326.6	26.8	232x25x17	YES	3000
YE512AM502400SU	2399	2400-2600	1 - 25	644	454	610.4	376.6	28.6	252x25x17	YES	3000
YE512AM502600SU	2599	2600-2800	1 - 25	694	504	660.4	426.6	30.5	272x25x17	YES	3000
YE512AM502800SU	2799	2800-3000	1 - 25	744	554	710.4	476.6	32.3	292x25x17	YES	3000
YE512AM503000SU	2999	3000-3200	1 - 25	794	604	760.4	526.6	34.1	312x25x17	YES	3000
YE512AM503200SU	3199	3200-3400	1 - 25	844	654	810.4	576.6	35.9	322x25x17	NO	3000
YE512AM503400SU	3399	3400-3600	1 - 25	894	704	860.4	626.6	37.7	352x25x17	NO	3000
YE512AM503600SU	3599	3600-3800	1 - 25	944	754	910.4	676.6	39.5	372x25x17	NO	3000
YE512AM503800SU	3799	3800-4000	1 - 25	994	804	960.4	726.6	41.3	392x25x17	NO	3000

! As you are in the design phase it will be important to determine the weight of your doors and provide for it with adequate panels thickness.

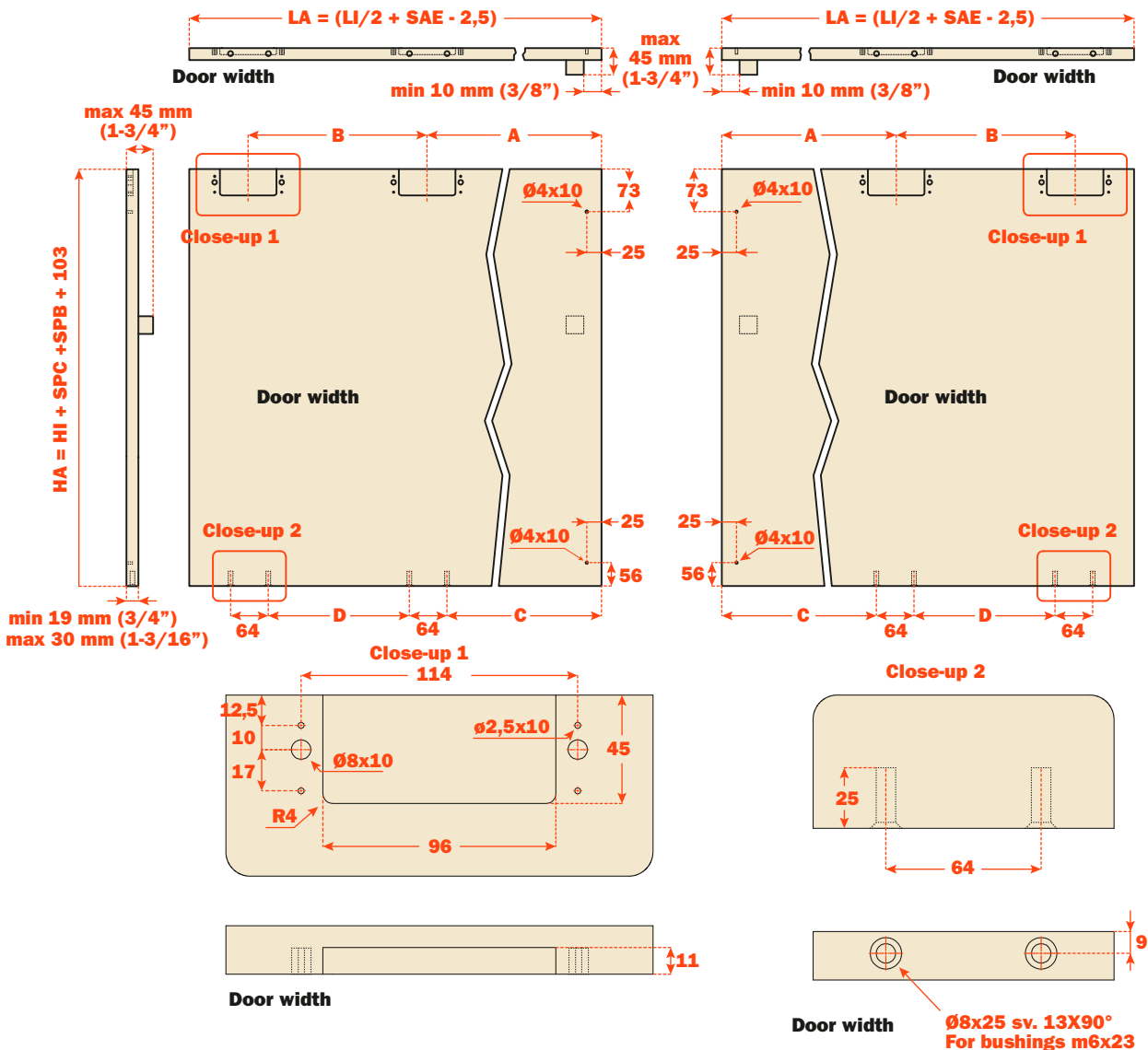

M50+ - Product codes and assembly specifications

Screw-mounted adjusters

Item #	Track length (Lp) mm	Li	Overlay (sae) mm	A	B	C	D	Packaging		Clipper frame	Max door height mm
								kg	cm		
YE512AM501200SU	1199	1200-1300	1 - 25	344	179	310.4	101.6	17.8	132x25x17	NO	2200
YE512AM501300SU	1299	1300-1400	1 - 25	369	204	335.4	126.6	18.7	142x25x17	NO	2200
YE512AM501400SU	1399	1400-1500	1 - 25	394	204	360.4	151.6	19.6	152x25x17	NO	2200
YE512AM501500SU	1499	1500-1600	1 - 25	419	254	385.4	176.6	20.7	162x25x17	NO	2200
YE512AM501600SU	1599	1600-1800	1 - 25	444	254	410.4	176.6	21.5	172x25x17	YES	2400
YE512AM501800SU	1799	1800-2000	1 - 25	494	304	460.4	226.6	23.3	192x25x17	YES	2400
YE512AM502000SU	1999	2000-2200	1 - 25	544	354	510.4	276.6	25	212x25x17	YES	3000
YE512AM502200SU	2199	2200-2400	1 - 25	594	404	560.4	326.6	26.8	232x25x17	YES	3000
YE512AM502400SU	2399	2400-2600	1 - 25	644	454	610.4	376.6	28.6	252x25x17	YES	3000
YE512AM502600SU	2599	2600-2800	1 - 25	694	504	660.4	426.6	30.5	272x25x17	YES	3000
YE512AM502800SU	2799	2800-3000	1 - 25	744	554	710.4	476.6	32.3	292x25x17	YES	3000
YE512AM503000SU	2999	3000-3200	1 - 25	794	604	760.4	526.6	34.1	312x25x17	YES	3000
YE512AM503200SU	3199	3200-3400	1 - 25	844	654	810.4	576.6	35.9	322x25x17	NO	3000
YE512AM503400SU	3399	3400-3600	1 - 25	894	704	860.4	626.6	37.7	352x25x17	NO	3000
YE512AM503600SU	3599	3600-3800	1 - 25	944	754	910.4	676.6	39.5	372x25x17	NO	3000
YE512AM503800SU	3799	3800-4000	1 - 25	994	804	960.4	726.6	41.3	392x25x17	NO	3000

As you are in the design phase it will be important to determine the weight of your doors and provide for it with adequate panels thickness.

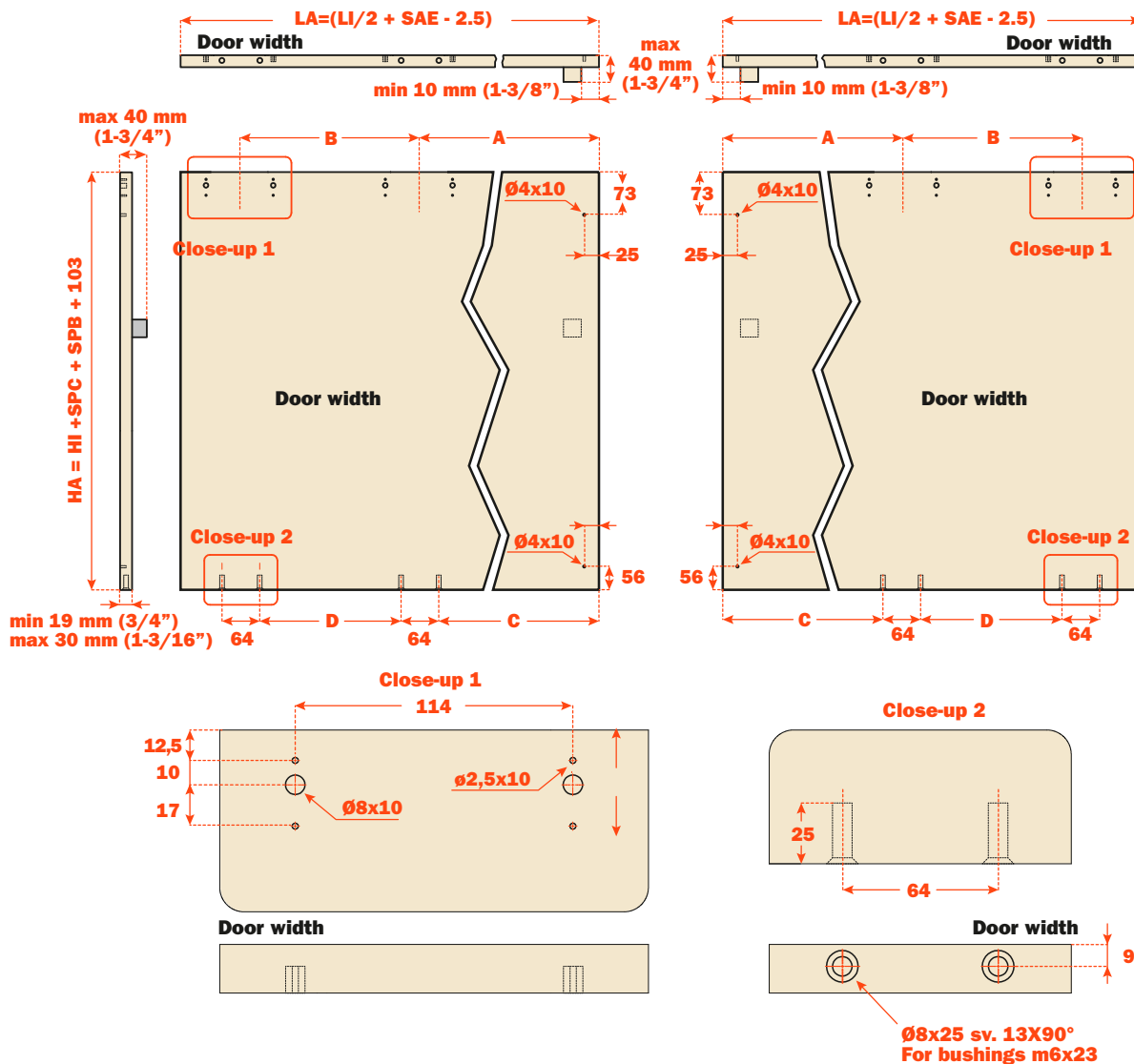

L70



L70

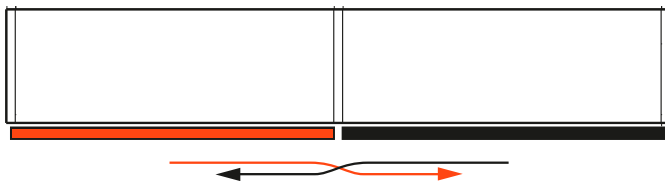

Coplanar sliding door system for tall double door cabinets with soft door opening and soft closing feature -heavy duty.

Product overview

- For wood or glass with aluminium frame doors;
- Door dimensions:
 - Max. weight capacity per door: 70 kg (154 lbs);
 - Width of the door: min. 800 mm (31-1/2"), max. 2000 mm (78-3/4");
 - Max. height of the door: 3000 mm (118-1/8");
 - Height of the door from floor level: 33 mm (1-11/32");
 - Min. thickness of the door: min. 19 mm (3/4");
 - Max. thickness of the door with handle: 45 mm (1-3/4");
 - Door height adjustment: ± 5 mm ($\pm 3/16$ ");
 - Door side adjustment: ± 3.5 mm ($\pm 1/8$ ");
- Available for cabinets with dimensions up to 200 mm (7-7/8") longer than the mechanism;
- Front levelling feet;
- **Applications with 3 doors possible only upon request as a custom order.**

THE KIT ASSEMBLY CONSISTS OF

<p>A</p>		<p>1 top sliding mechanism</p>	
<p>B</p>		<p>1 bottom sliding mechanism</p>	
		<p>Front covers</p>	
<p>C</p>	<p>For each mechanism The quantity of the following components will change according to the length of the mechanism: - upper profile clips; - lower profile clips.</p>	<p>D</p> <p>x 1 x 1</p> <p>E</p> <p>x 1 / 2</p>	<p>For each door 1 complete upper adjustment system; 1 vertical upper adjustment system; 1 or 2 bottom adjustment systems.</p>
<p>F</p> <p>x 1 x 2 x 2 x 2</p>	<p>For each door 1 upper angular plate; 2 screws TCEI M5x16; 2 screws TPSEI M4x12; 2 black bumpers</p>	<p>For each mechanism 4 die cast bushings M4x10; 6 die cast bushings M6x13.</p> <p>x 4 x 6</p>	
<p>x 1 x 1 x 1</p>	<p>For each mechanism 1 hex wrench 4 mm; 1 hex wrench 2.5 mm; 1 wrench metric 10 mm.</p>	<p>For each mechanism 1 cover for left foot; 1 cover for right foot.</p> <p>x 1 x 1</p>	

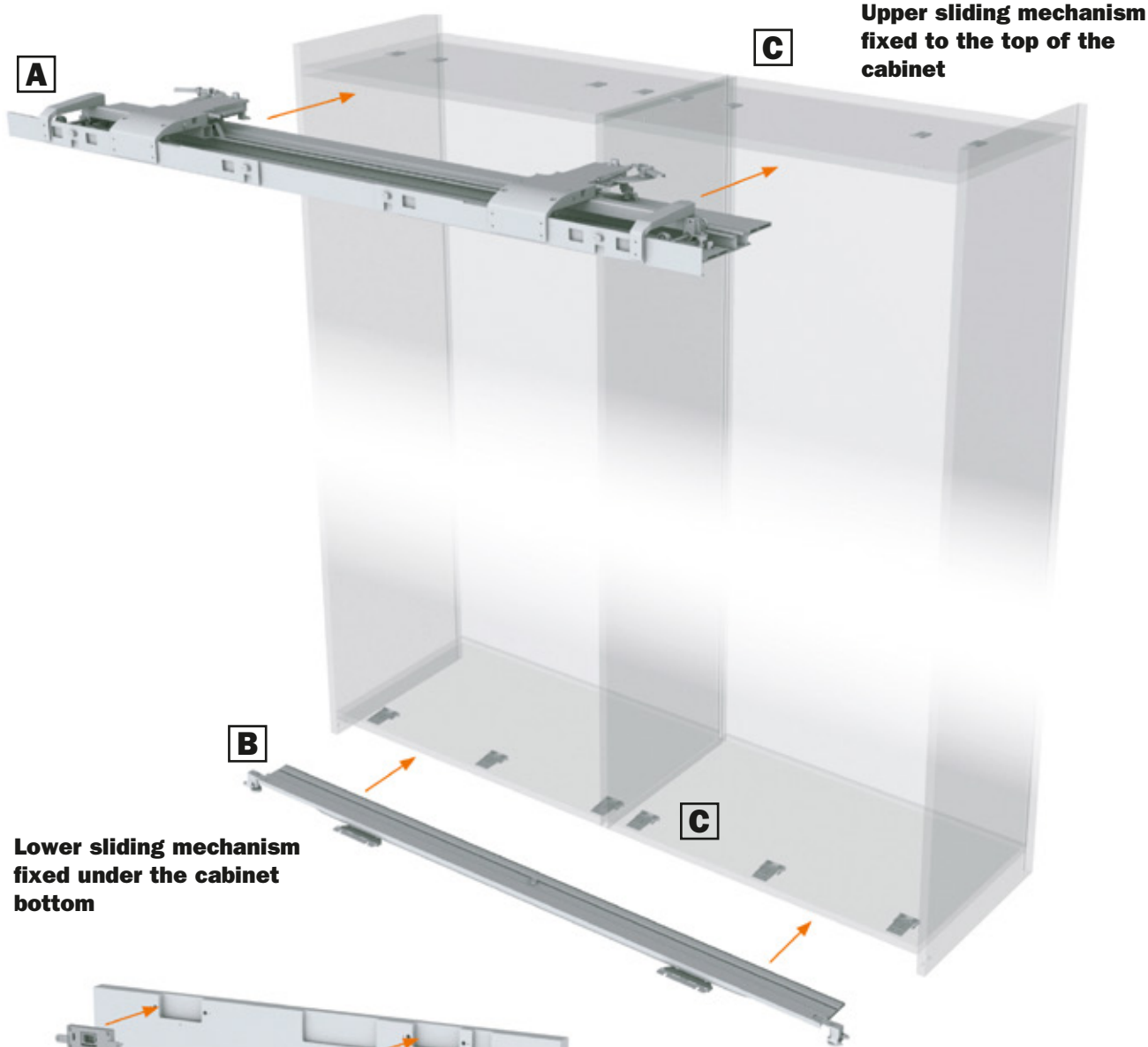

Lower sliding mechanism fixed under the cabinet bottom

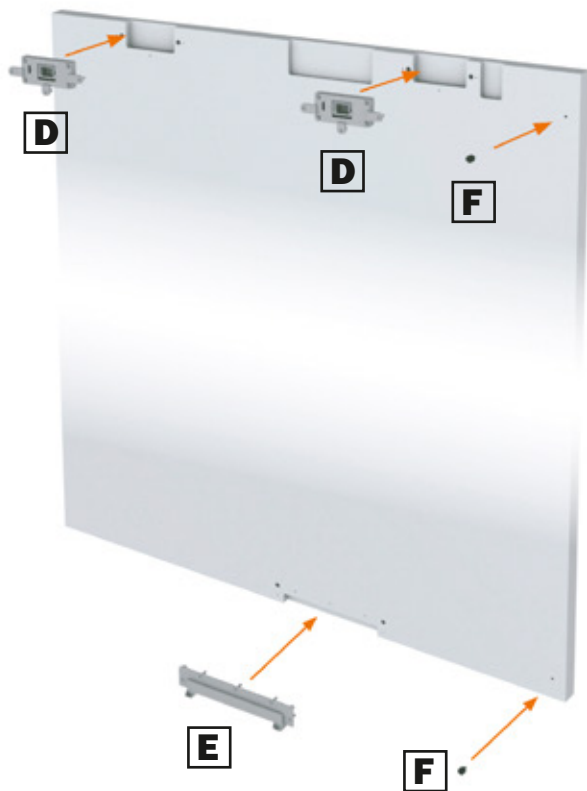

Position the adjuster blocks on the doors

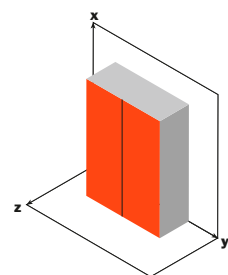

TYPE "33"

Door distance from the floor level 33 mm (1-11/32")

CODE REFERENCES

LI	Internal cabinet width (mm)
LA	Door width (mm)
HI	Internal cabinet height (mm)
SPI	Support panel thickness (mm)
SAE	Door overlay on side panel (mm)

HA	Door height (mm)
HT	Total cabinet height (mm)
SPE	Side panel thickness (mm)
DBS	Space between track and side panel (mm)
SPC	Top panel thickness
SPB	Bottom panel thickness
LP	Track length

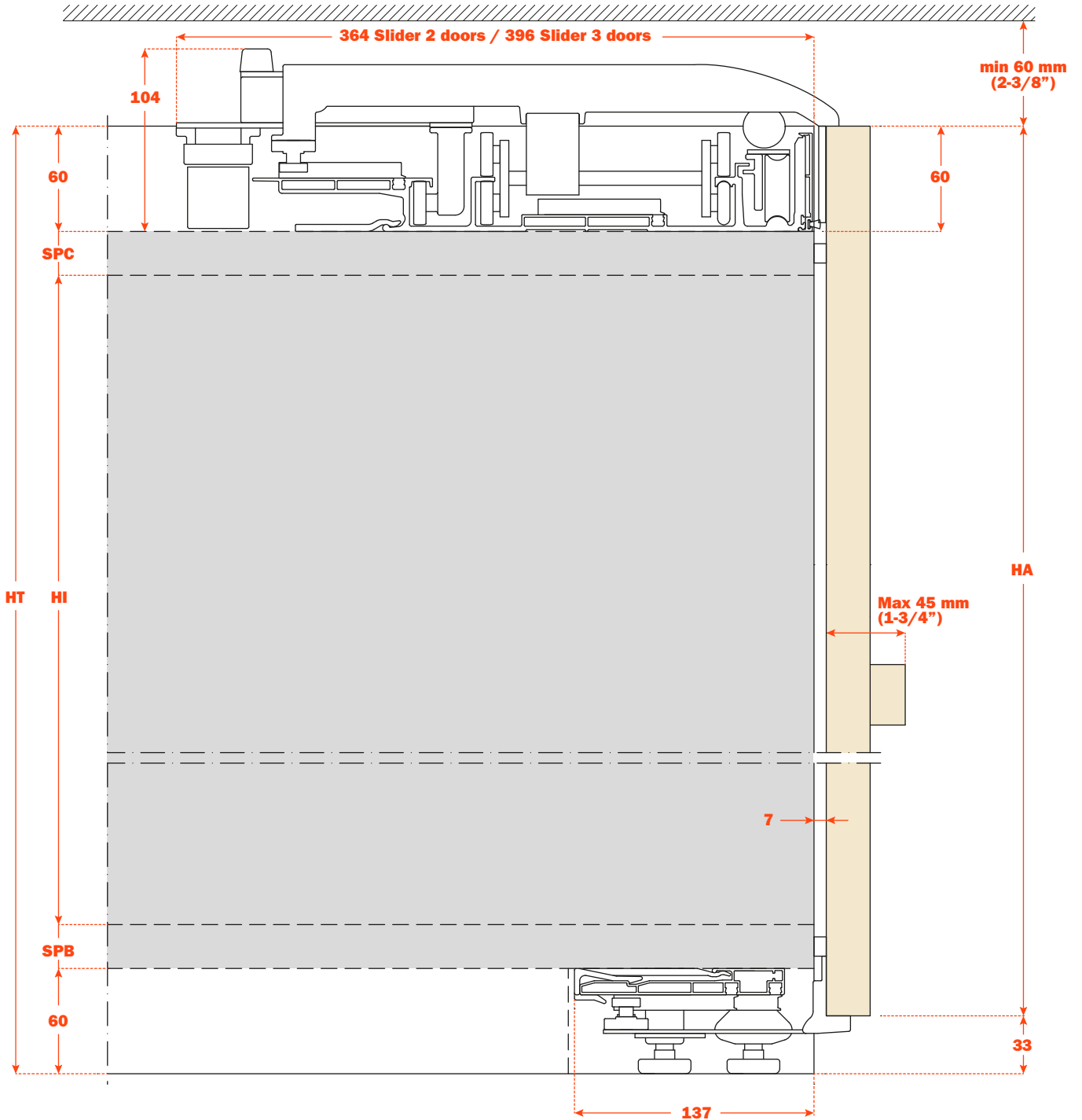

FLEXIBILITY OF INSTALLATION

The S70 2 doors stock size slider mechanisms can be installed on a carcass which may exceed the dimensions of the track itself by 200 mm (7-7/8"). The protrusion of the door in the open position is described with the formula: $DBS + SAE - (SPI/2) + 4.5$

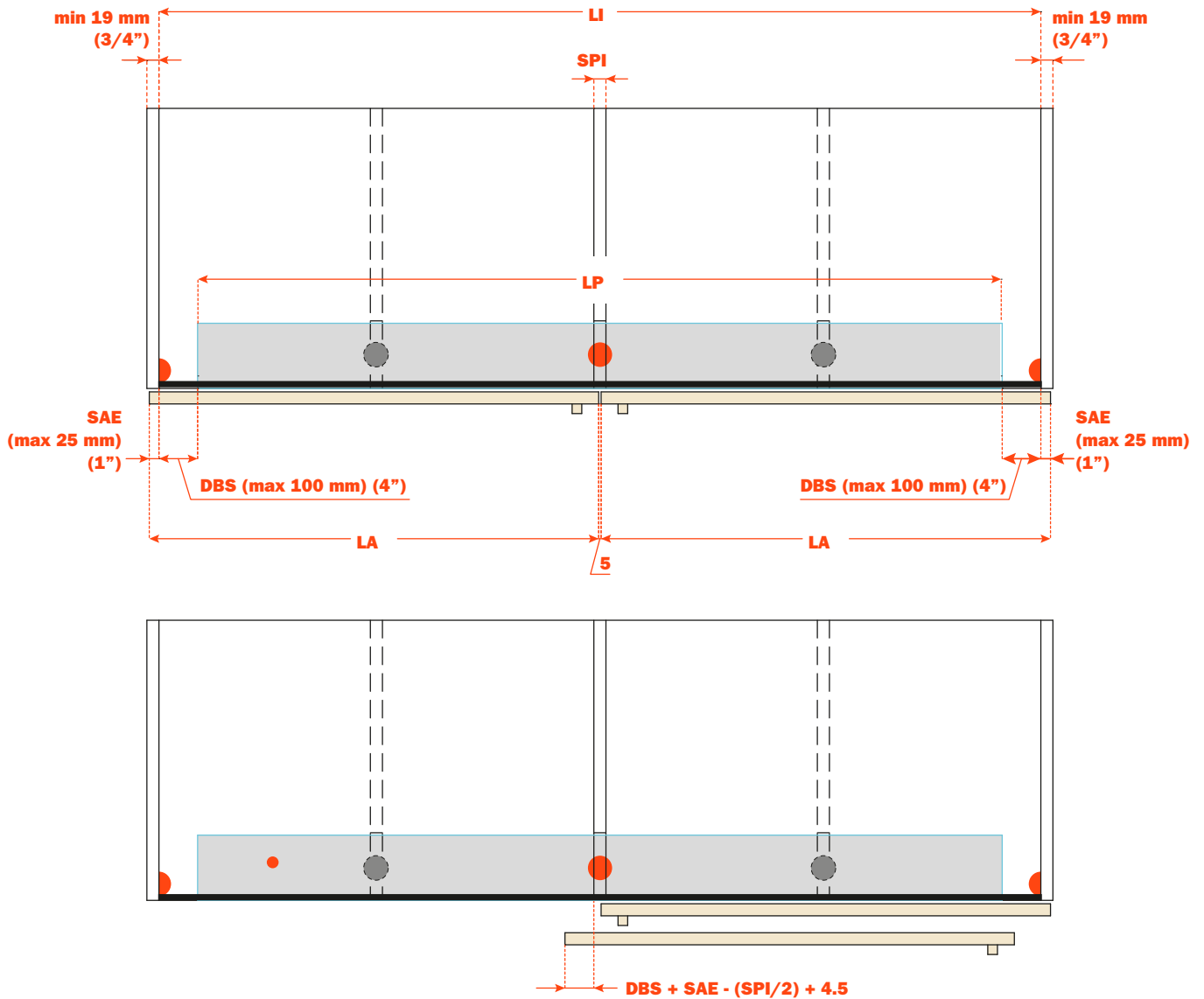

- Feet supplied with the track.
- Additional feet supplied on track (LP) over 2999 mm (118-1/8").

L70 - Product codes and assembly specifications LEFT DOOR

Item #	Mechanism length (Lp) mm	Li	Overlay (SAE) Mm	B	C	D	E	F	G	Packaging	
										Weight kg	Dimensions cm
YE302A1600SA	1599	1600-1800	1 - 25	169	303	154	472	341	-	26	175x46x19
YE302A1800SA	1799	1800-2000	1 - 25	169	353	204	522	391	-	29.4	195x46x19
YE302A2000SA	1999	2000-2200	1 - 25	169	403	254	572	441	-	32.8	215x46x19
YE302A2200SA	2199	2200-2400	1 - 25	169	453	304	622	491	-	36.2	235x46x19
YE302A2400SA	2399	2400-2600	1 - 25	169	503	354	672	541	-	39.6	255x46x19
YE302A2600SA	2599	2600-2800	1 - 25	219	503	354	722	591	425	41.2	275x46x19
YE302A2800SA	2799	2800-3000	1 - 25	269	503	354	772	641	475	43.4	295x46x19
YE302A3000SA	2999	3000-3200	1 - 25	319	503	354	822	691	525	46.8	315x46x19
YE302A3200SA	3199	3200-3400	1 - 25	369	503	354	872	741	575	49.2	335x46x19
YE302A3400SA	3399	3400-3600	1 - 25	419	503	354	922	791	625	51.9	355x46x19
YE302A3600SA	3599	3600-3800	1 - 25	469	503	354	972	841	675	54.6	375x46x19
YE302A3800SA	3699	3800-4000	1 - 25	519	503	354	1022	891	725	57.3	395x46x19

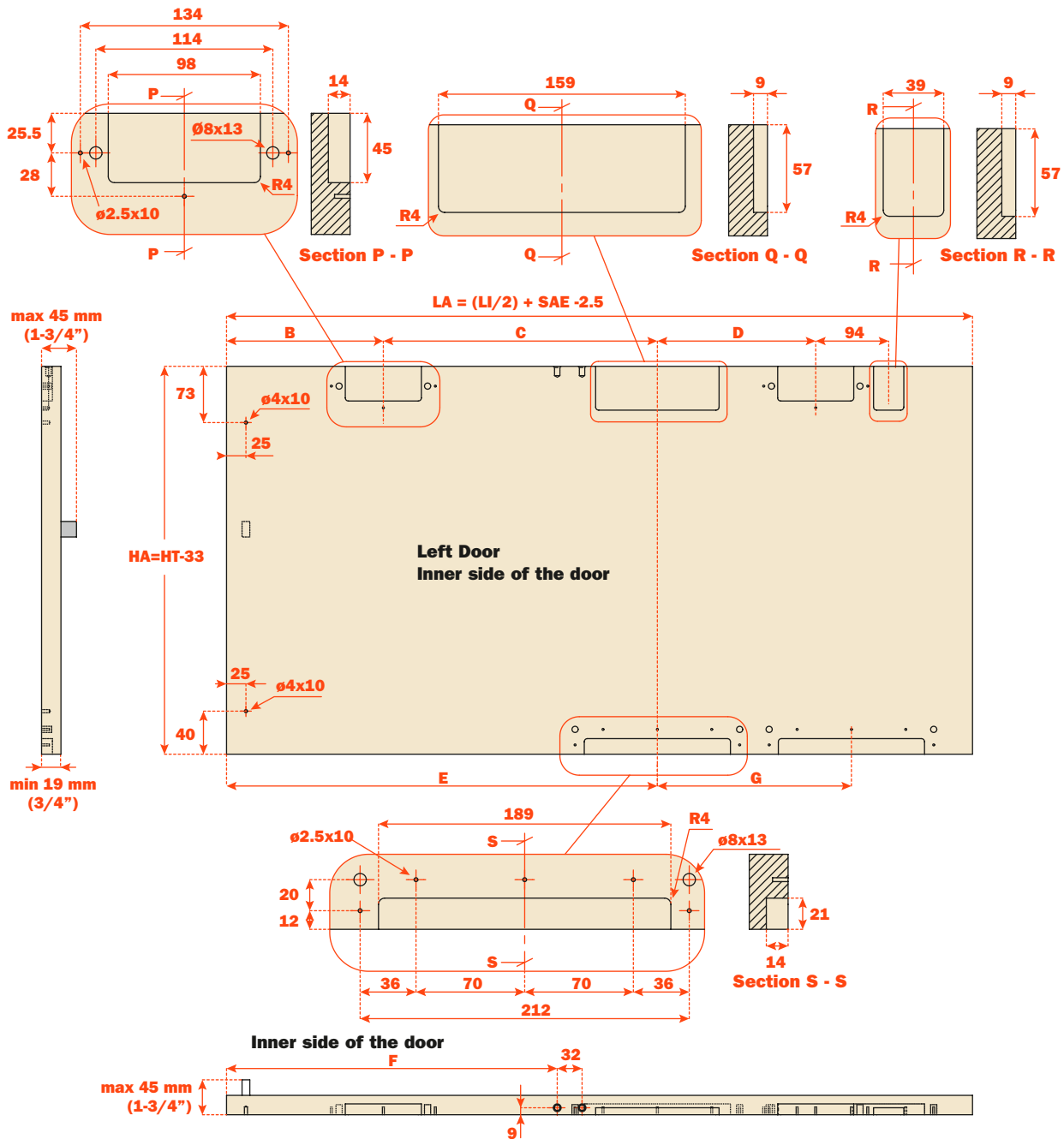



As you are in the design phase it will be important to determine the weight of your doors and provide for it with adequate panels thickness.

CODE REFERENCES

- LI** Internal cabinet width (mm)
- LA** Door width (mm)
- HI** Internal cabinet height (mm)
- SPI** Support panel thickness (mm)
- SAE** Door overlay on side panel (mm)
- HA** Door height (mm)
- B/C/D/E/F/G** See chart

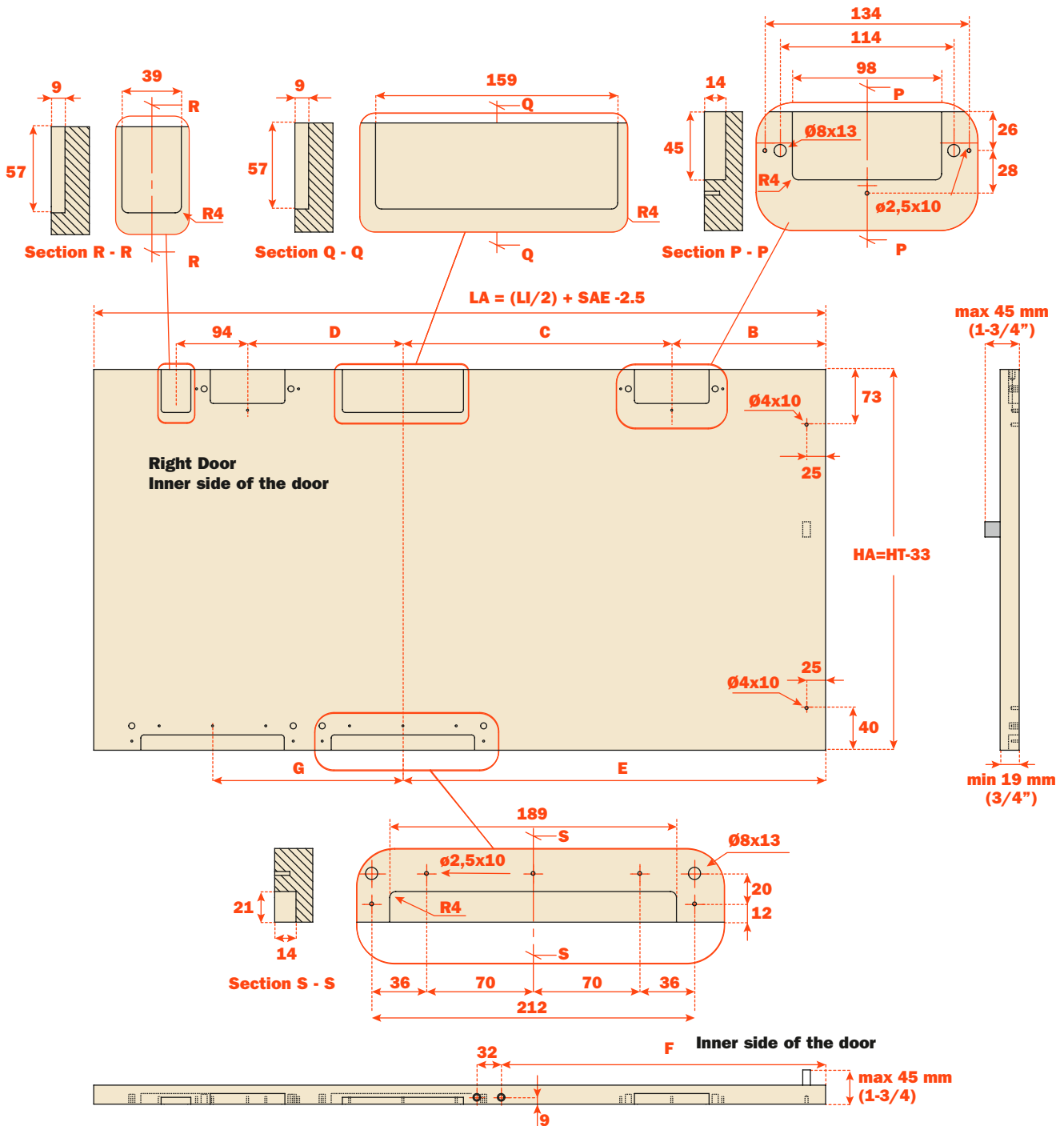

Pocket door system



Pocket door system



Salice pocket door system smooth lateral assisted positive opening and cushioned soft-close movements, which are controlled by a safety device.

Product overview

Mechanism elements

- Aluminium profiles: 6060T5 alloy, silver anodized.
- Components made of plastic, steel and zinc alloy.

Door features

- Maximum weight for each door* 66 lbs (30 kg) (distributed evenly).
- Thickness:
 - minimum 19 mm (3/4");
 - maximum 30 mm (1 3/16").
- Width:
 - minimum 400 mm (15 3/4");
 - maximum 900 mm (35 7/16").
- Height:**
 - minimum 1550 mm (61 1/32");
 - maximum 2500 mm (98 7/16").
- Door vertical adjustment +4/-1 mm.
- Door horizontal adjustment ± 2 mm.
- Door front adjustment ± 4 mm.
- Assisted door extraction movement.
- Soft closing buffer.
- Material:
 - a) wood or derivatives;
 - b) metal and glass frame;

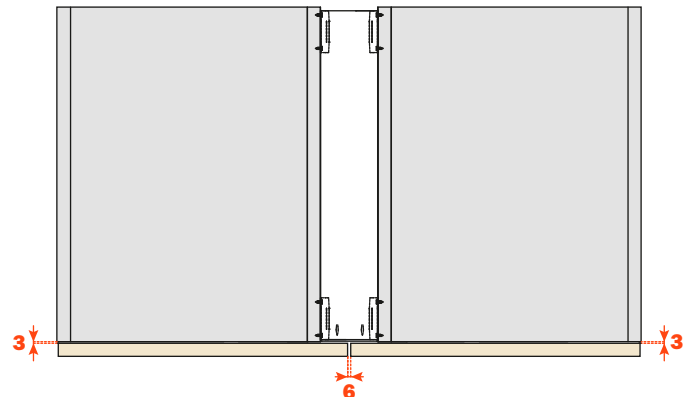
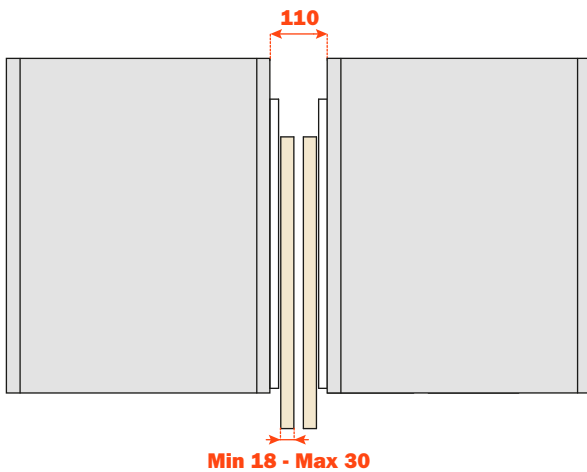
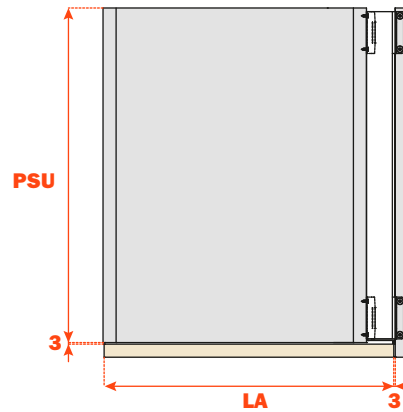
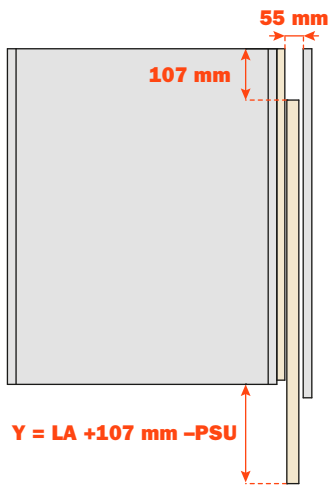

- 1 Patented cam movement with assisted door insertion and extraction.
- 2 Soft closing buffer.
- 3 Mounting with clips to facilitate extraction of the mechanism in case of maintenance.
- 4 Sliding carriage.
- 5 Quick coupling hinges.
- 6 Front adjustments on the hinge coupling column.
- 7 Profile cover caps (included in the standard versions).

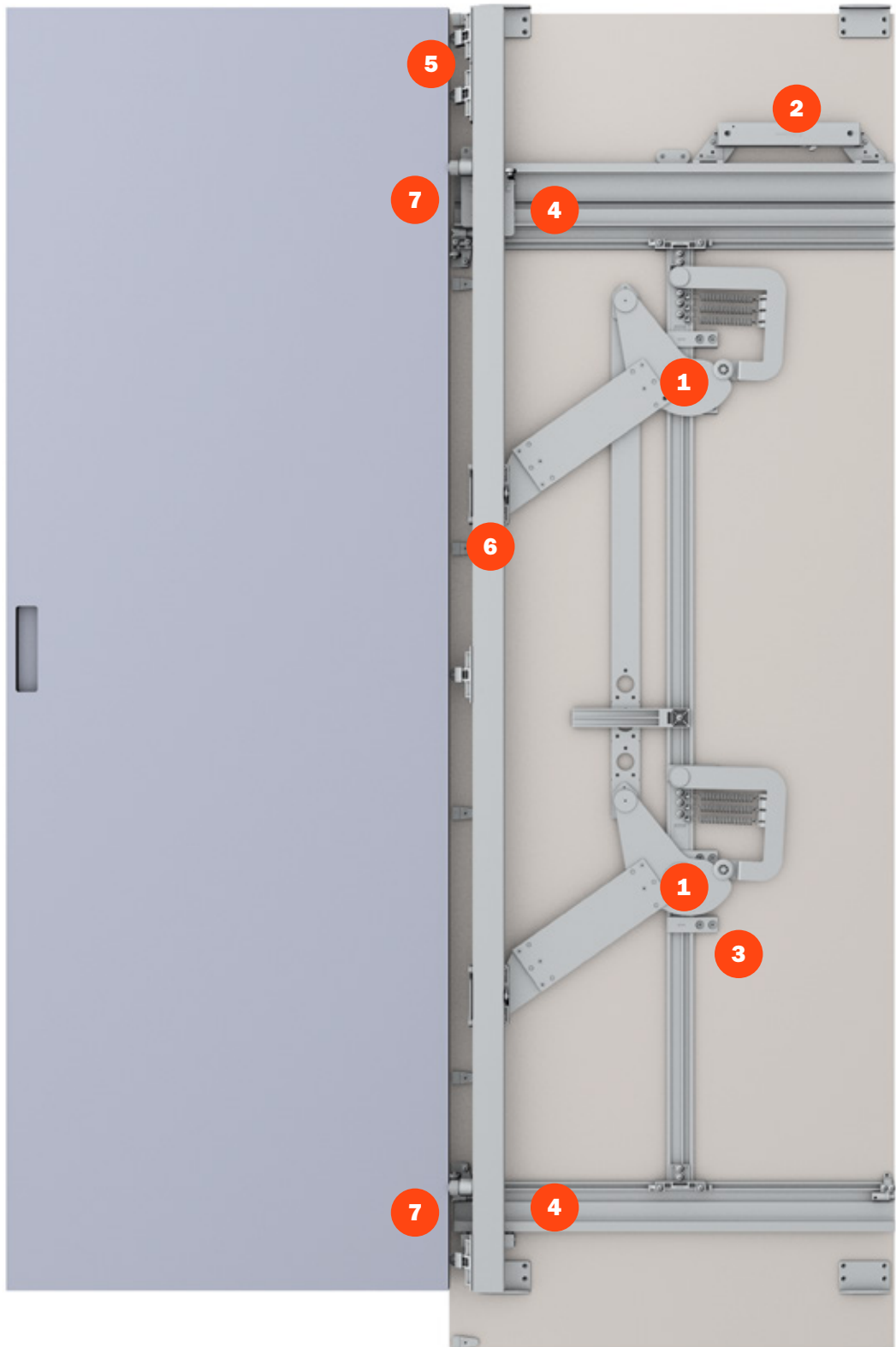

Pocket door system

The mechanism is cut to size based to desired length and delivered partially assembled.

A cam-carriage connection (tab. 1) must be ordered together with the mechanism kit (tab. 2) according to the utilized depth of the cabinet structure (PSU) and the height of the door (HA). Refer to the installation manual for the assembly operations.

Calculating the minimum structure dimensions

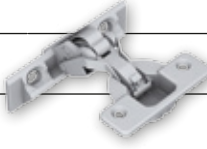
		PSU* (mm)											
		400-500		501-600		601-700		701-800		801-900			
HA (mm)	Min	Max	Min	Max	Min	Max	Min	Max	Min	Max			
	1546	1696	1668	1757	1790	1879					3 x		max 18 kg
	1697	2091	1758	2152	1880	2213	2002	2274	2124	2335	4 x		max 24 kg
	2092	2500	2153	2500	2214	2500	2275	2500	2336	2500	5 x		max 30 kg



PSU* = Utilised Depth of Cabinet Structure

PS** = Depth of Cabinet Structure

Cam-carriage connection (tab.1)

	Cod.	PSU (mm)	HA (mm)			(kg)	(mc)	(mm)
			max 3	max 4	max 5			
 x 2								
	YE55KIT0101	400-500	1546	1697	2092	0,65	0,001	285x40x100
	YE55KIT0102	501-600	1668	1758	2153	0,80	0,001	285x40x100
	YE55KIT0103	601-700	1790	1880	2214	1,00	0,001	285x40x100
	YE55KIT0104	701-800		2002	2275	1,25	0,001	405x40x100
	YE55KIT0105	801-900		2124	2336	1,50	0,001	405x40x100

Mechanism KIT (tab.2)

	Cod.		HA (mm)	Kg	Mc	mm
	YE55AAD2500SA	Right	1550 ÷ 2500	16	0.09	415 x 105 x 2600
	YE55AAS2500SA	Left				

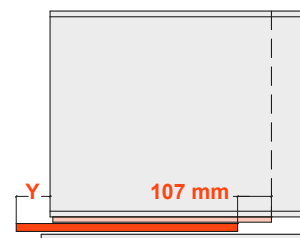
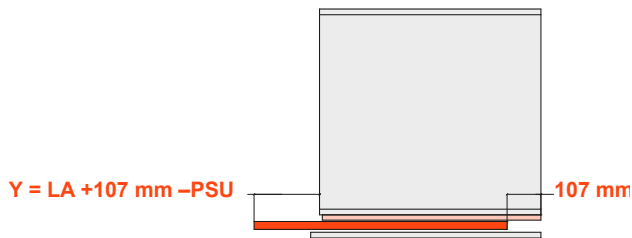
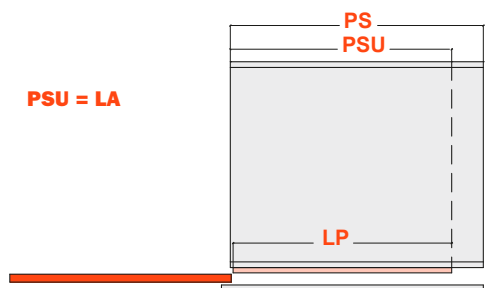
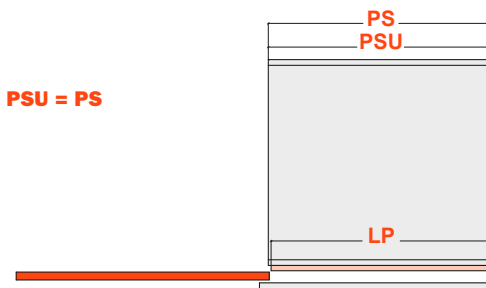
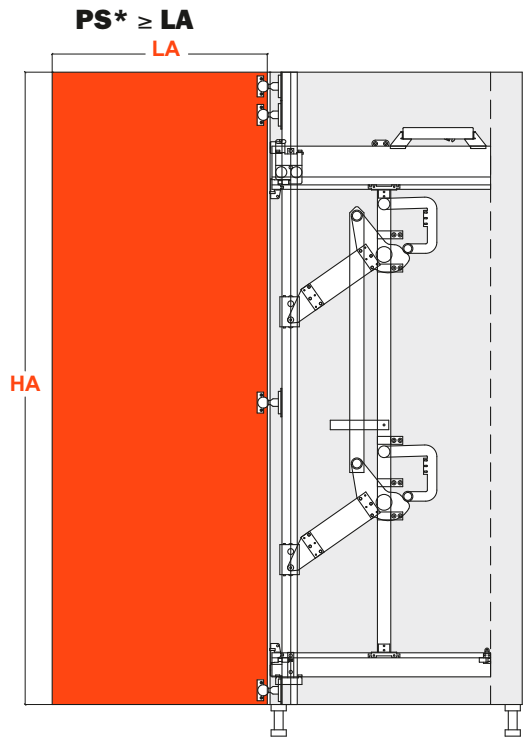
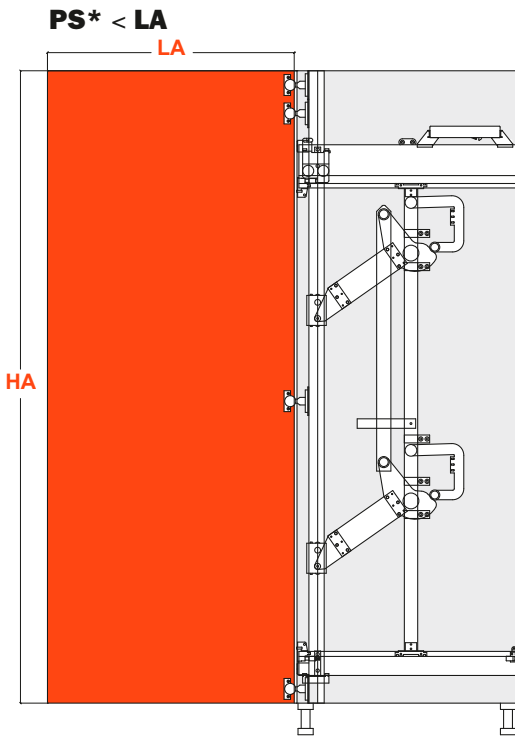



Accessories

Structure lateral connection

	Cod.	PS (mm)	(kg)	(mc)	(mm)
	YE55KIT0001	400÷650	0,85	0,003	90x45x770
	YE55KIT0002	650÷900	1,0	0,004	90x45x1020
	YE55KIT0005	400÷650	0,85	0,003	90x45x770
	YE55KIT0006	650÷900	1,0	0,004	90x45x1020
	YE55KIT0003	400÷650	1,5	0,003	130x45x770
	YE55KIT0004	650÷900	1,8	0,004	130x45x1020

Accessories

Front cover kit

	Cod.	\longleftrightarrow L		(kg)	(mc)	(mm)
		(m)				
	YE55KIT0201	2,6		0,7	0,03	100x100x2700
	YE55KIT0202	2,6		0,7	0,03	100x100x2700

Magnetic kit for door and structure

	Cod.	pz		(kg)	(mc)	(mm)

MOVER





Sliding system with vertical gliding for wall cabinets. The mechanism is concealed inside an aluminium profile always hidden from the door. The door moves on two lateral telescopic guides and can be stopped in any position.

Product overview

- Vertical sliding system for single door;
- Door dimensions:
 - 900 W x 600 H mm (35-7/16" x 23-5/8")
weight from 6 (13lbs) to 8 kg (18 lbs)
 - 1200 W x 600 H mm (47-7/32" x 23-5/8")
weight from 10 (22lbs) to 12 kg (27 lbs)
 - 1800 W x 600 H mm (71-1/16" x 23-5/8")
weight from 15 (33 lbs) to 17 kg (38 lbs)
 - 2400 W x 600 H mm (94-1/2" x 23-5/8")
weight from 19 (42 lbs) to 21 kg (46 lbs)
- Side panel thickness 20 mm (3/4");
- Height adjustment ± 3 mm ($\pm 1/8$ ");
- Door weight adjustment ± 1 kg (± 2 lbs);
- 480 mm height door available as special order.

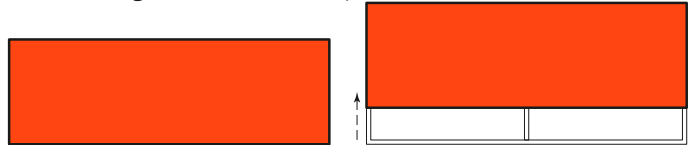

THE KIT ASSEMBLY CONSISTS OF

A



Horizontal aluminium profile

B



Pair of full-extension telescopic guides

C



Sliding profile for central panel (only for versions with door from 1800 to 2400 mm)

D

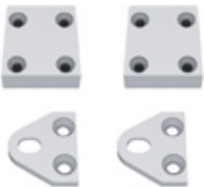

E



Packaging with accessories

Insert the aluminium profile (A) on the on the inserts (D) already fixed on the lateral panels

A
Fix on the lateral panels the support (D) for the aluminium profile

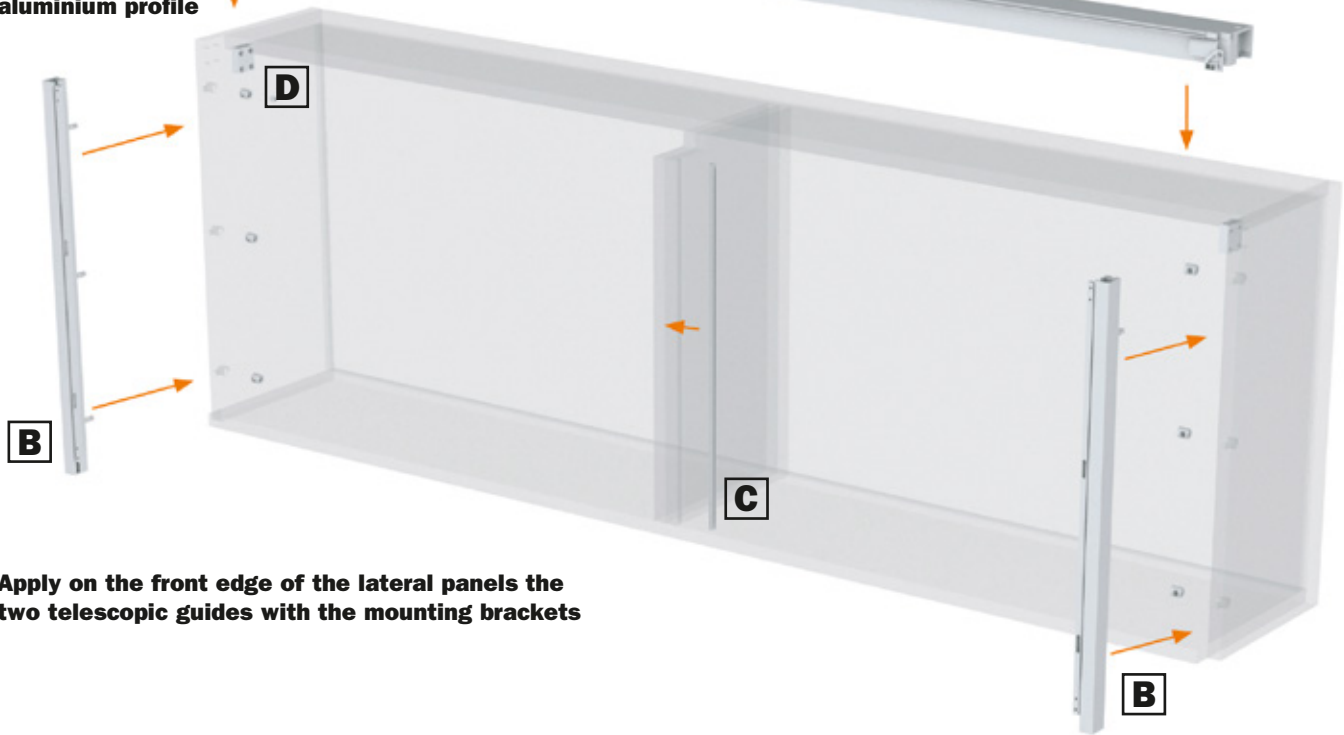

Apply on the front edge of the lateral panels the two telescopic guides with the mounting brackets

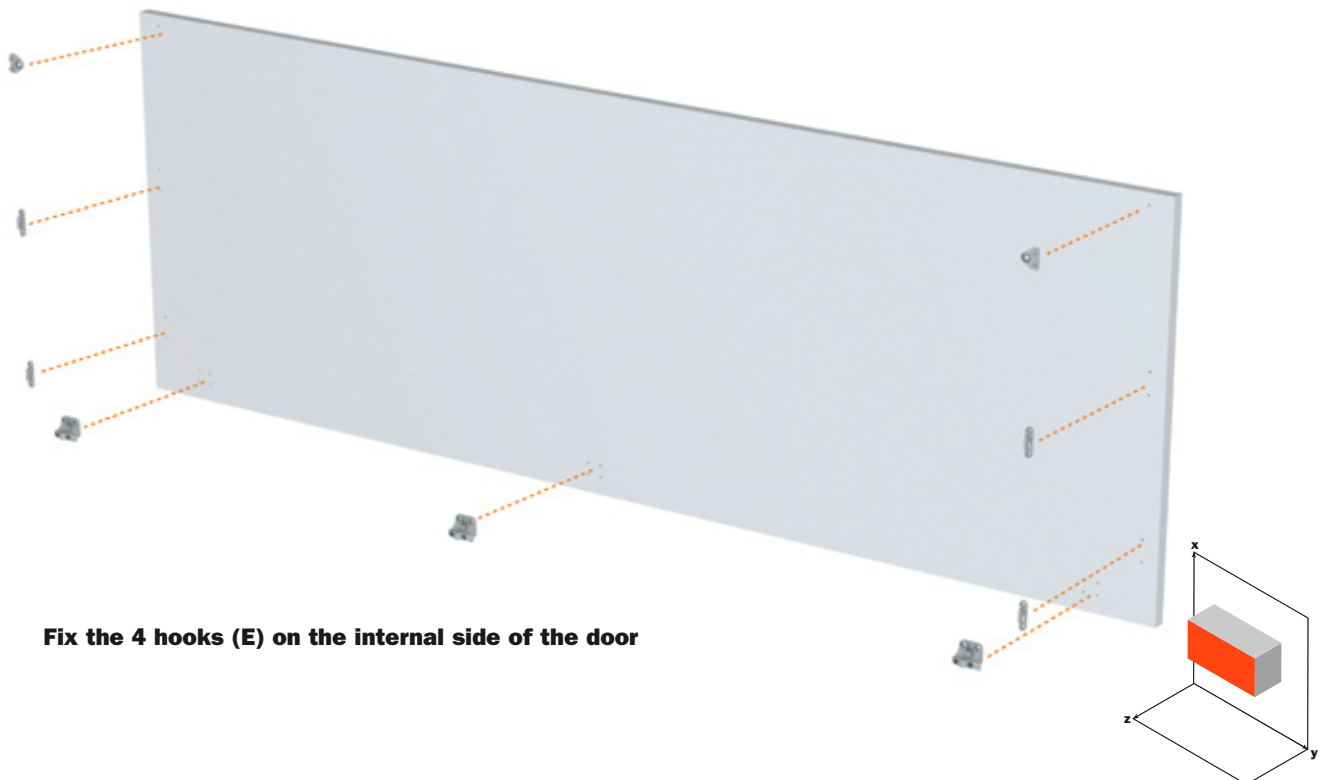

Fix the 4 hooks (E) on the internal side of the door

Item	Side panels thickness mm	Door width mm	Door weight Kg	Packaging	
				Weight Kg	Dimensions cm
YE2809006020	20	900	6-8	5.7	125x10x10
YE2812006020	20	1200	10-12	6.9	125x10x10
YE2818006020	20	1800	15-17	9.9	185x10x10
YE2824006020	20	2400	19-21	10.9	245x10x10
YE2809004820	20	900	5-7	5.4	96x10x10
YE2812004820	20	1200	7-9	6.7	125x10x10
YE2818004820	20	1800	11-13	9.6	185x10x10
YE2824004820	20	2400	16-18	10.6	245x10x10



As you are in the design phase it will be important to determine the weight of your doors and provide for it with adequate panels thickness.

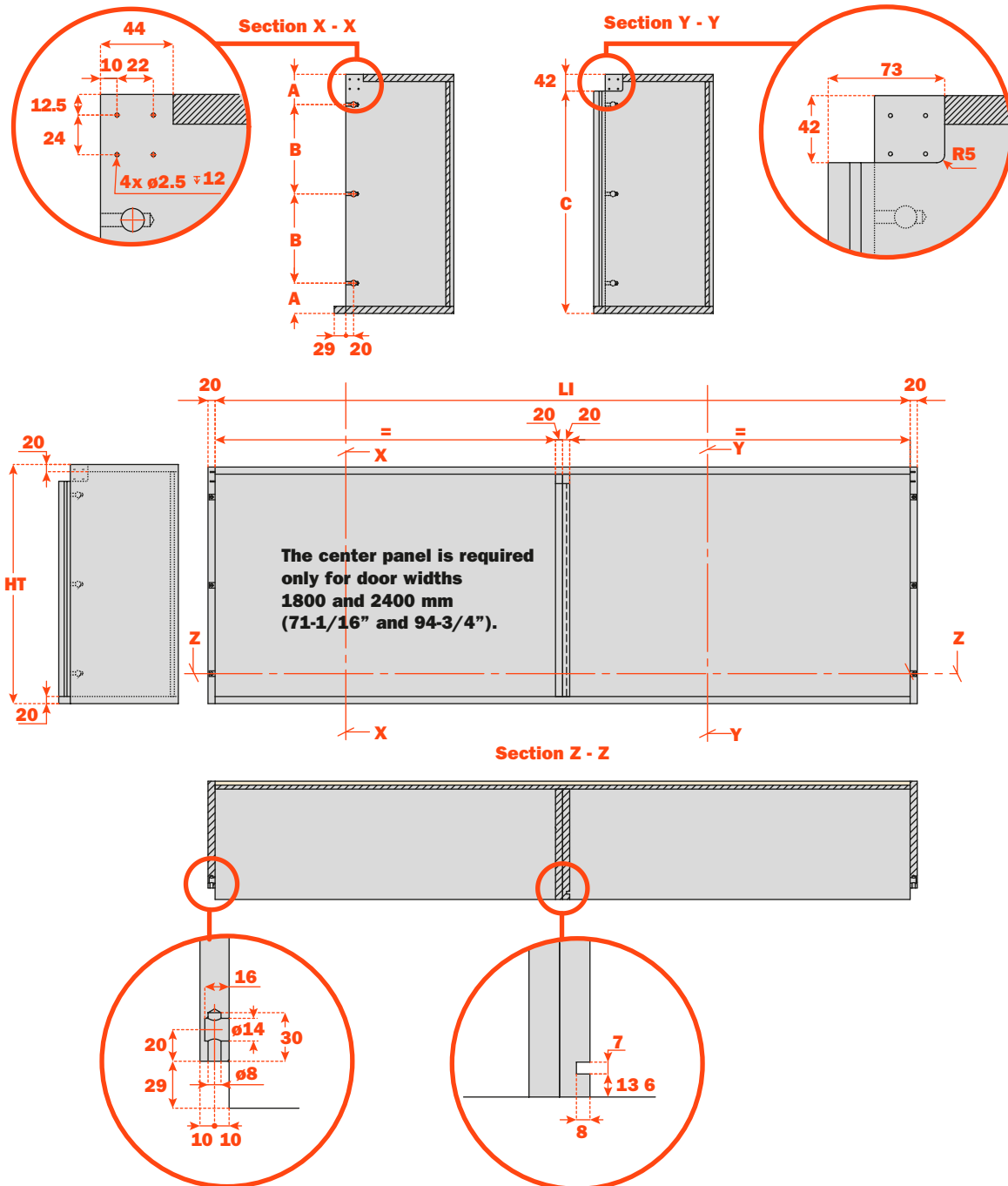

Product codes and assembly specifications DOOR

Item	Description	HT	LI	A	B	C	HA	LA	D	E	F	Weight Kg
YE2809006020	900x600 20 mm	600	863	76	224		597	900	224.5			6/8
YE2812006020	1200x600 20 mm	600	1163	76	224		597	1200	224.5			10/12
YE2818006020	1800x600 20 mm	600	1763	76	224	558	597	1800	224.5	733.5	817.5	15/17
YE2824006020	2400x600 20 mm	600	2363	76	224	558	597	2400	224.5	1033.5	1117.5	19/21
YE2809004820	900x480 20 mm	480	863	80	160		477	900	104.5			5/7
YE2812004820	1200x480 20 mm	480	1163	80	160		477	1200	104.5			7/9
YE2818004820	1800x480 20 mm	480	1763	80	160	438	477	1800	104.5	733.5	817.5	11/13
YE2824004820	2400x480 20 mm	480	363	80	160	438	477	2400	104.5	1033.5	1117.5	16/18



As you are in the design phase it will be important to determine the weight of your doors and provide for it with adequate panels thickness.

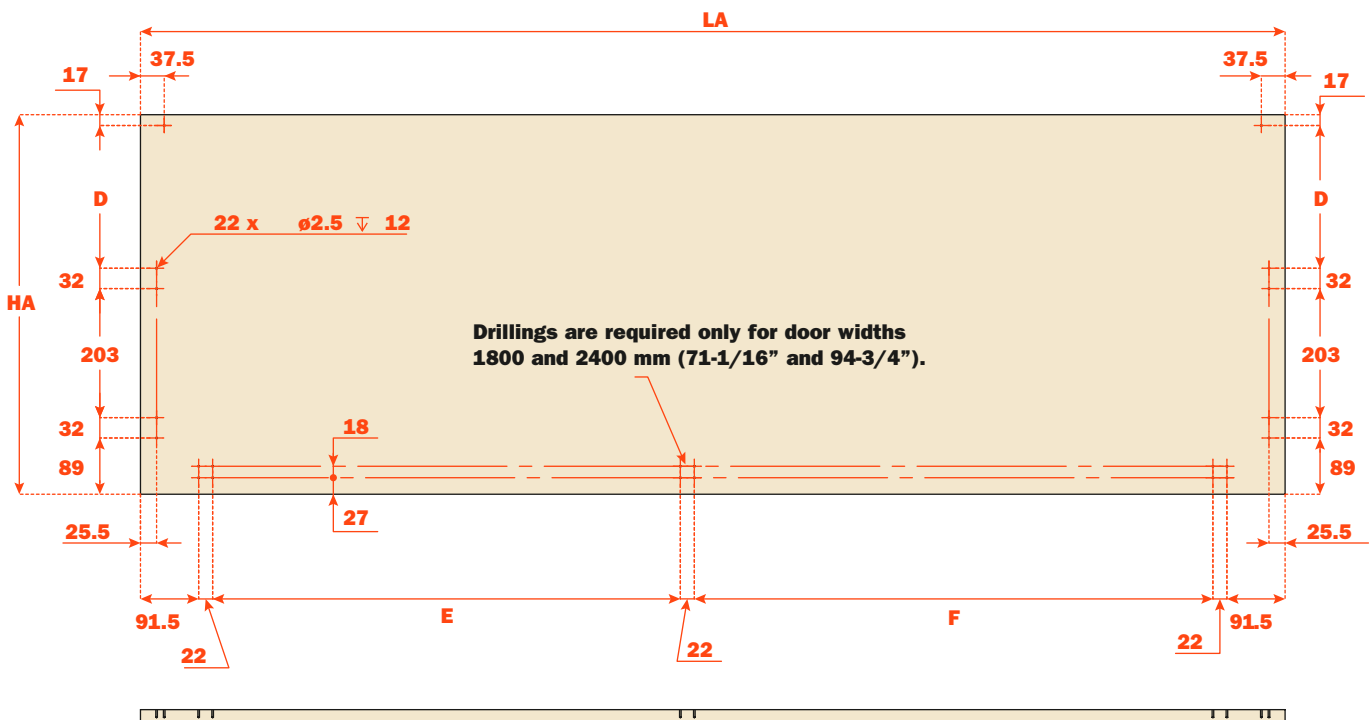

CODE REFERENCES

- LI** Internal cabinet width (mm)
- LA** Door width (mm)
- HA** Door height (mm)
- HT** Total cabinet height (mm)
- A/B/C/D/E/F** See chart

clipper

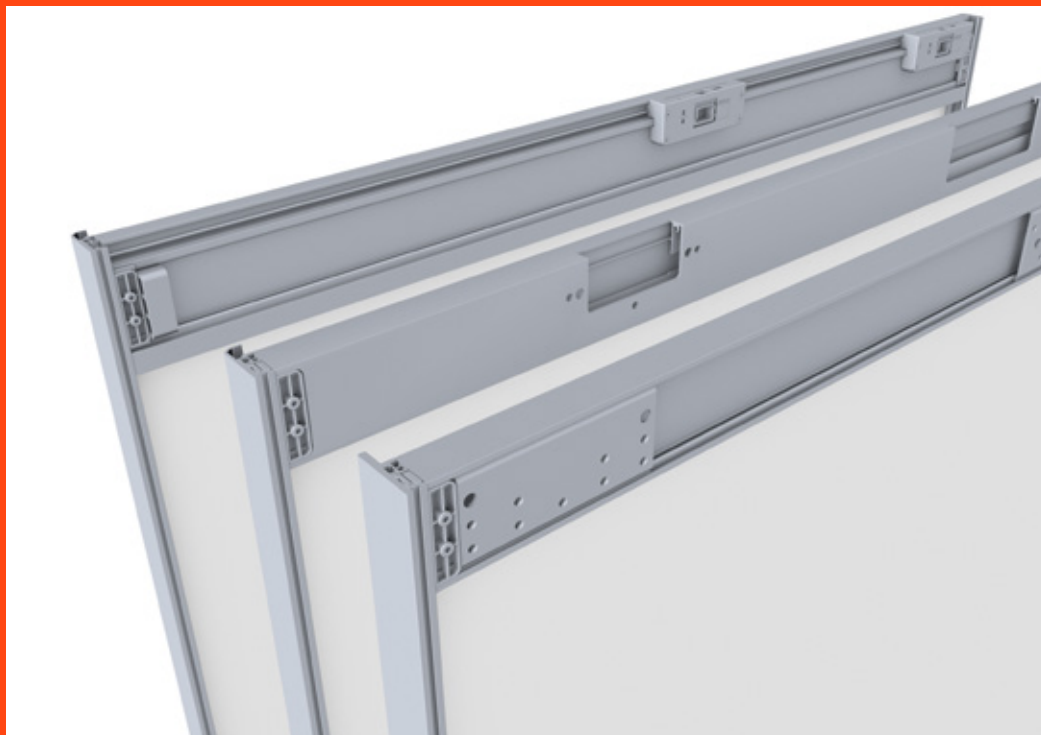

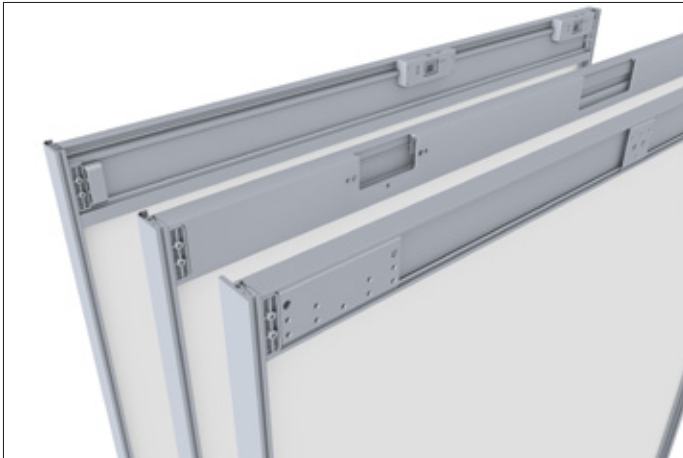

Aluminum frame door system for use with the M50+ and L70.

Product overview

- Crossbeams in anodized silver aluminum ARC 10, L = 3000 mm (118-1/8");
- Max. width of the door: 1500 mm (59");
- Standbeams in anodized silver aluminum ARC 10, L = 2650mm (104-1/4");
- Max. height of the door: 2650 mm (104-1/4);
- Rubber gasket for 4 mm (5/32") glass;
- Rubber gasket for 8 mm (5/16") panels;
- Possibility to combine the door with more elements (glass or panels) thanks to the intermediate crossbeams.
- For the slider Large system it is necessary to carry out processes on the upper and lower crossbeam with the methods indicated in the technical documentation of the mechanism.

Patented joint system

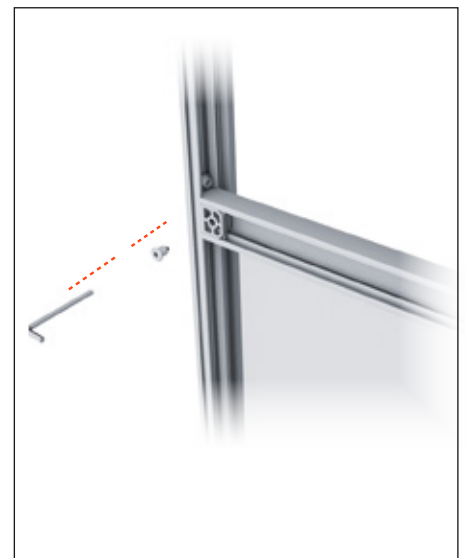
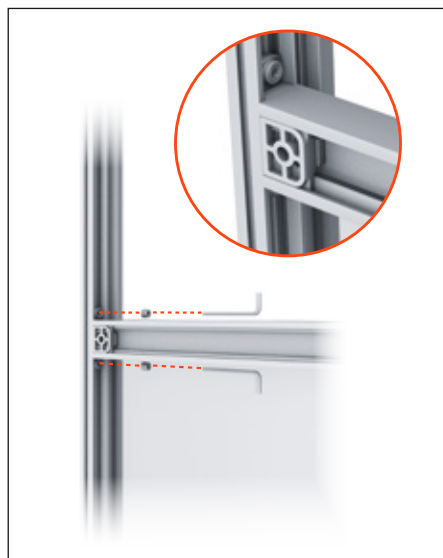
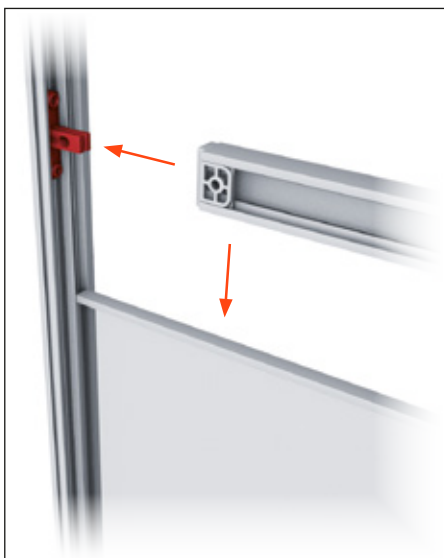
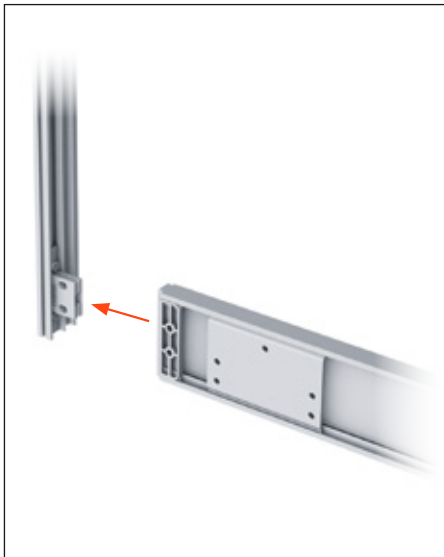

Calculation for sizing of the profiles and glass

LA = door width

HA = door height

N = number of intermediate profiles

Intermediate profiles length

(LA - 26)

Crossbeam length

HA

Glass (or panel) length









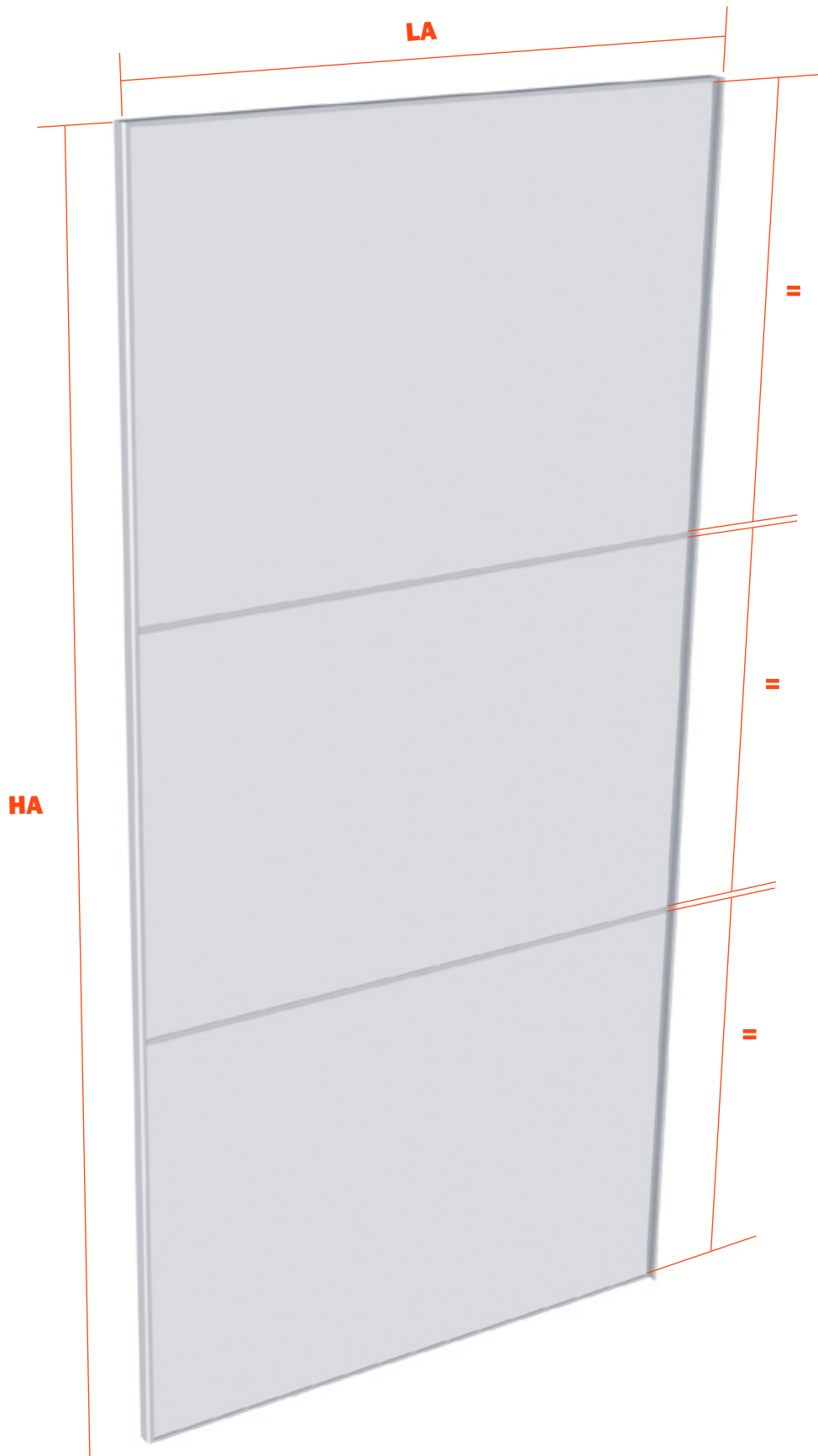



(LA - 18.6)

Glass (or panel) height

[HA - 8.6 - (3.4 x N)] : (N + 1)

For doors with a whole panel or glass N = 0

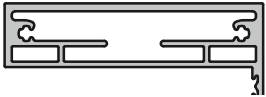



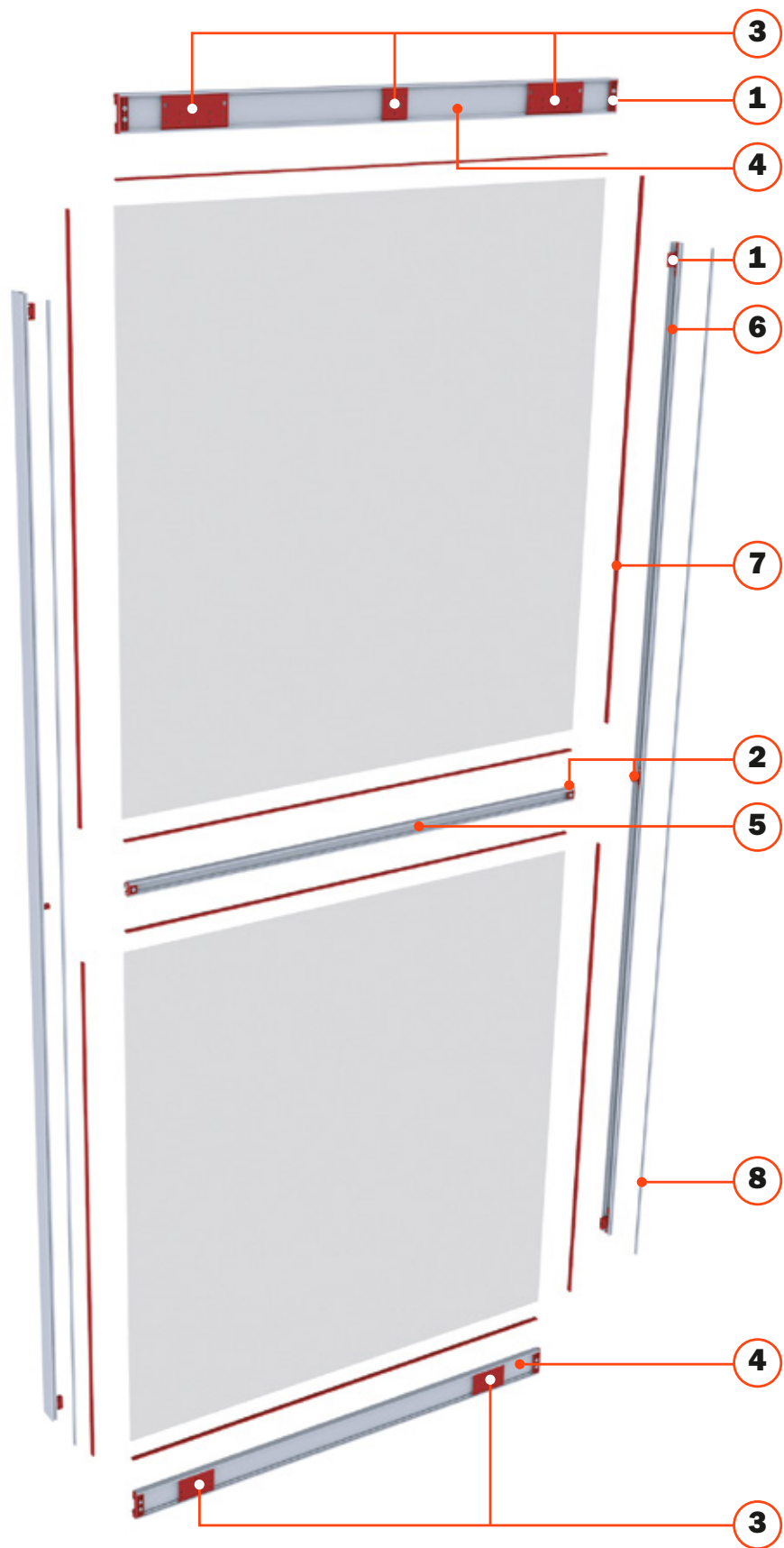



<p>1</p> <p>Details for assembly of the corners</p> 	<p>5</p>  <p>Crossbeam brace</p>  <p>Intermediate crossbeam</p>
<p>2</p> <p>Details for assembly of the crossbeams</p> 	<p>6</p>  <p>Side standbeam with handle</p>  <p>Side standbeam</p>
<p>3</p> <p>Elements for application on M50+</p> 	<p>7</p>  <p>Rubber gasket for 4 mm glass</p>  <p>Rubber gasket for 8 mm panels</p>
<p>4</p>  <p>Crossbeam for M50+</p>  <p>Crossbeam for L70</p>	<p>8</p>  <p>Dust strip</p>

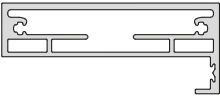

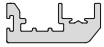
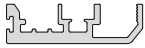

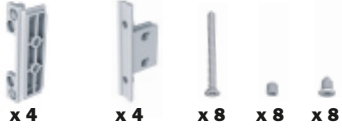
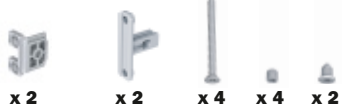
How to order Clipper frames for Slider L by kit

Kit for glass door of maximum width 1500mm and with rear reinforcing slat.

Item	(mm)	KIT YE43KIT1300 (pz)	
3 Upper and lower crossbeam	3000	1	
4 Concealed intermediate crossbeam	1500	1	
5 Vertical profile without handle	2650	1	
5 Side standbeam with handle	2650	1	
6 Rubber gasket for glass 4 mm	3000	4	
7 Grey brush H7	6000	1	
1 Corner joint kit	-	1	 x 4 x 4 x 8 x 8 x 8
2 Crossbeam joint kit	-	1	 x 2 x 2 x 4 x 4 x 2
Screws kit for adjuster	-	1	 x 16

Optional

Item	(mm)	KIT YE43KIT1400 (pz)	KIT YE43KIT1500 (pz)	
4 Junction kit for concealed and dividing intermediate crossbeam	1500	1	-	 x 2 x 2 x 4 x 4x 2
6 Rubber gasket for panels 8 mm	3000	-	4	

Examples

3 x YE43KIT1300

Slider L70-Slider L100 3 doors

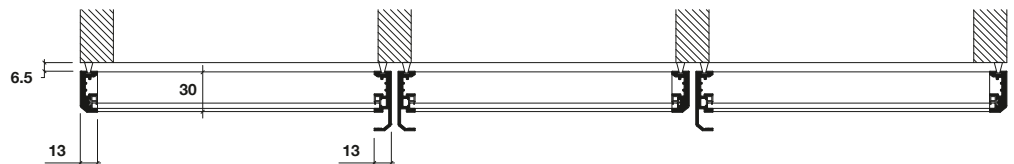

2 x YE43KIT1300



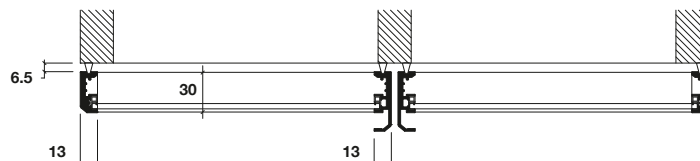





Slider L100 2 doors



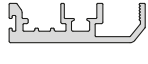

The upper and lower horizontal profiles must be machined as indicated in the technical documentation provided with the mechanism.

How to order Clipper frames for M50+ by kit

Kit for door with glass of a maximum width of 1500 mm and with rear reinforcing slat.

Item	(mm)	KIT YE43KIT1200 (pz)	
5 Upper and lower crossbeam	3000	1	
6 Concealed intermediate crossbeam	1500	1	
7 Vertical profile without handle	2650	1	
7 Vertical profile with handle	2650	1	
8 Rubber gasket for glass 4 mm	3000	4	
9 Grey brush H7	6000	1	
9 Grey brush H5	6000	1	
1 Corner joint kit	-	1	
2 Crossbeam joint kit Querstrebe Montage Set	-	1	
3 4 Carriage connector and buffer kit	-	1	

Optional

Item	(mm)	KIT YE43KIT1400 (pz)	KIT YE43KIT1500 (pz)	
5 Junction kit for concealed and dividing intermediate crossbeam	1500	1	-	
7 Rubber gasket for panels 8 mm	3000	-	4	

Examples





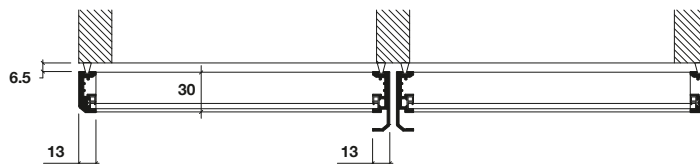

2 x **YE43KIT1200**

Slider **M35-50** 2 doors



How to order Clipper frames by item.





PROFILES

	Length mm	Item	Pack. pcs.	Dimensions mm	
④ Crossbeam M50+	L = 3000	YE43BTL03000A	2	110x30	
④ Crossbeam L70	L = 3000	YE43BTB03000A	2	27x30	
⑤ Bracing crossbeam	L = 3000	YE43BTC03000A	2	30x18	
⑤ Intermediate crossbeam	L = 3000	YE43BTD03000A	2	30x30	
⑥ Side standbeam with handle	L = 2650	YE43BTH02650A	2	45x13	
⑥ Side standbeam	L = 2650	VE43BTG02650A	2	31x13	

RUBBER GASKET

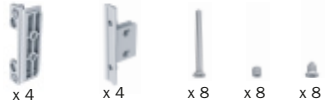
	Length mm	Item	Pack. pz.	Weight Kg	Volume mc	Dimensions mm	
Rubber gasket for glass 4 mm	L = 3000	YE43TAG0500	10	6.8	0.03	110x85x3050	
Rubber gasket for panels 8 mm	L = 3000	YE43TAG0510	10	5.5	0.03	110x85x3050	
Dust strip H 7 mm for M50+		YE43PB4829G	10	2.2	0.02		

JOINTS AND PLATES

	Length mm	Item	Pack. pz.	Weight Kg	Volume mc	Dimensions mm	
Corner joint kit	-	YE43KIT0001	2	8.3	0.007	290x285x80	 x 4 x 4 x 8 x 8 x 8
Crossbeam joint kit	-	YE43KIT0002	2	3.9	0.004	240x200x85	 x 2 x 2 x 4 x 4 x 2
Carriage hook up kit M50+	-	YE43KIT0006	2	6.8	0.001	330x310x110	 x 2 x 2 x 2 x 2 x 8 x 8
Screws kit for adjuster L70	-	YE43KIT0005	2	0.45	0.001	125x115x115	 x 16

SALICE AMERICA Inc.

2123 CROWN CENTRE DRIVE
USA - CHARLOTTE, NC 28227
TEL. 1-800-222-9652/704-841-7810
FAX 704-841-7808
info.salice@saliceamerica.com
www.saliceamerica.com